

850nm Infrared LED Emitter

# LZ4-00R408

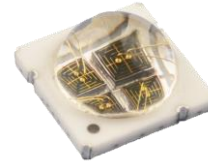

## Key Features

- High Efficacy 850nm 5W Infrared LED
- Ultra-small foot print – 7.0mm x 7.0mm
- Surface mount ceramic package with integrated glass lens
- Low Thermal Resistance (2.8°C/W)
- Individually addressable die
- Very high Radiant Flux density
- Autoclave compliant (JEDEC JESD22-A102-C)
- JEDEC Level 1 for Moisture Sensitivity Level
- Lead (Pb) free and RoHS compliant
- Reflow solderable (up to 6 cycles)
- Emitter available on Serially Connected MCPCB (optional)

## Typical Applications

- Inspection
- Security lighting

## Description

The LZ4-00R408 850nm Infrared LED emitter generates 2.0W nominal output at 5W power dissipation in an extremely small package. With a 7.0mm x 7.0mm ultra-small footprint, this package provides exceptional radiant flux density. The patent-pending design has unparalleled thermal and optical performance. The high quality materials used in the package are chosen to optimize light output and minimize stresses which results in monumental reliability and lumen maintenance. The robust product design thrives in outdoor applications with high ambient temperatures and high humidity.

## Part number options

### Base part number

Part number	Description
LZ4-00R408-xxxx	LZ4 emitter
LZ4-40R408-xxxx	LZ4 emitter on 1 channel Standard Star MCPCB

### Bin kit option codes

R4, Infrared (850nm)			
Kit number suffix	Min flux Bin	Color Bin Range	Description
0000	P	F08 – F08	full distribution flux; full distribution wavelength

Notes:

1. Default bin kit option is -0000

## Radiant Flux Bins

Table 1:

Bin Code	Minimum Radiant Flux ( $\Phi$ ) @ $I_F = 700\text{mA}$ <sup>[1,2]</sup> (W)	Maximum Radiant Flux ( $\Phi$ ) @ $I_F = 700\text{mA}$ <sup>[1,2]</sup> (W)
P	1.60	2.00
Q	2.00	2.40
R	2.40	3.00

Notes for Table 1:

1. Radiant flux performance guaranteed within published operating conditions. LED Engin maintains a tolerance of  $\pm 10\%$  on flux measurements.
2. Future products will have even higher levels of radiant flux performance. Contact LED Engin Sales for updated information.

## Peak Wavelength Bin

Table 2:

Bin Code	Minimum Peak Wavelength ( $\lambda_p$ ) @ $I_F = 700\text{mA}$ <sup>[1]</sup> (nm)	Maximum Peak Wavelength ( $\lambda_p$ ) @ $I_F = 700\text{mA}$ <sup>[1]</sup> (nm)
F08	835	875

Notes for Table 2:

1. LED Engin maintains a tolerance of  $\pm 2.0\text{nm}$  on peak wavelength measurements.

## Forward Voltage Bins

Table 3:

Bin Code	Minimum Forward Voltage ( $V_F$ ) @ $I_F = 700\text{mA}$ <sup>[1,2]</sup> (V)	Maximum Forward Voltage ( $V_F$ ) @ $I_F = 700\text{mA}$ <sup>[1,2]</sup> (V)
0	6.8	10.8

Notes for Table 3:

1. Forward Voltage is binned with all four LED dice connected in series.
2. LED Engin maintains a tolerance of  $\pm 0.16\text{V}$  for forward voltage measurements for the four LEDs.

## Absolute Maximum Ratings

Table 4:

Parameter	Symbol	Value	Unit
DC Forward Current <sup>[1]</sup>	$I_F$	1000	mA
Peak Pulsed Forward Current <sup>[2]</sup>	$I_{FP}$	2000	mA
Reverse Voltage	$V_R$	See Note 3	V
Storage Temperature	$T_{stg}$	-40 ~ +125	°C
Junction Temperature	$T_J$	125	°C
Soldering Temperature <sup>[4]</sup>	$T_{sol}$	260	°C
Allowable Reflow Cycles		6	
Autoclave Conditions <sup>[5]</sup>		121°C at 2 ATM, 100% RH for 168 hours	
ESD Sensitivity <sup>[6]</sup>		> 8,000 V HBM Class 3B JESD22-A114-D	

Notes for Table 4:

- Maximum DC forward current (per die) is determined by the overall thermal resistance and ambient temperature. Follow the curves in Figure 10 for current derating.
- Pulse forward current conditions: Pulse Width  $\leq$  10msec and Duty Cycle  $\leq$  10%.
- LEDs are not designed to be reverse biased.
- Solder conditions per JEDEC 020D. See Reflow Soldering Profile Figure 3.
- Autoclave Conditions per JEDEC JESD22-A102-C.
- LED Engin recommends taking reasonable precautions towards possible ESD damages and handling the LZ4-00R408 in an electrostatic protected area (EPA). An EPA may be adequately protected by ESD controls as outlined in ANSI/ESD S6.1.

## Optical Characteristics @ $T_C = 25^\circ\text{C}$

Table 5:

Parameter	Symbol	Typical	Unit
Radiant Flux (@ $I_F = 700\text{mA}$ ) <sup>[1]</sup>	$\Phi$	2.58	W
Radiant Flux (@ $I_F = 1000\text{mA}$ ) <sup>[1]</sup>	$\Phi$	3.60	W
Peak Wavelength	$\lambda_p$	850	nm
Viewing Angle <sup>[2]</sup>	$2\Theta_{1/2}$	100	Degrees
Total Included Angle <sup>[3]</sup>	$\Theta_{0.9}$	120	Degrees

Notes for Table 5:

- Radiant flux typical value is for all four LED dice operating concurrently at rated current.
- Viewing Angle is the off axis angle from emitter centerline where the radiant power is ½ of the peak value.
- Total Included Angle is the total angle that includes 90% of the total radiant flux.

## Electrical Characteristics @ $T_C = 25^\circ\text{C}$

Table 6:

Parameter	Symbol	Typical	Unit
Forward Voltage (@ $I_F = 700\text{mA}$ ) <sup>[1]</sup>	$V_F$	7.2	V
Forward Voltage (@ $I_F = 1000\text{mA}$ ) <sup>[1]</sup>	$V_F$	7.6	V
Temperature Coefficient of Forward Voltage	$\Delta V_F / \Delta T_J$	-8.0	mV/°C
Thermal Resistance (Junction to Case)	$R\Theta_{J-C}$	2.8	°C/W

Notes for Table 6:

- Forward Voltage typical value is for all four LED dice connected in series.

## IPC/JEDEC Moisture Sensitivity Level

Table 7 - IPC/JEDEC J-STD-20 MSL Classification:

Level	Floor Life		Soak Requirements			
	Time	Conditions	Standard	Accelerated	Time (hrs)	Conditions
1	1 Year	≤ 30°C/ 85% RH	168 +5/-0	85°C/ 85% RH	n/a	n/a

Notes for Table 7:

- The standard soak time is the sum of the default value of 24 hours for the semiconductor manufacturer's exposure time (MET) between bake and bag and the floor life of maximum time allowed out of the bag at the end user or distributor's facility.

## Average Radiant Flux Maintenance Projections

Based on long-term WHTOL testing, LED Engin projects that the LZ Series will deliver, on average, 70% Radiant Flux Maintenance at 65,000 hours of operation at a forward current of 700 mA. This projection is based on constant current operation with junction temperature maintained at or below 110°C.

## Mechanical Dimensions (mm)

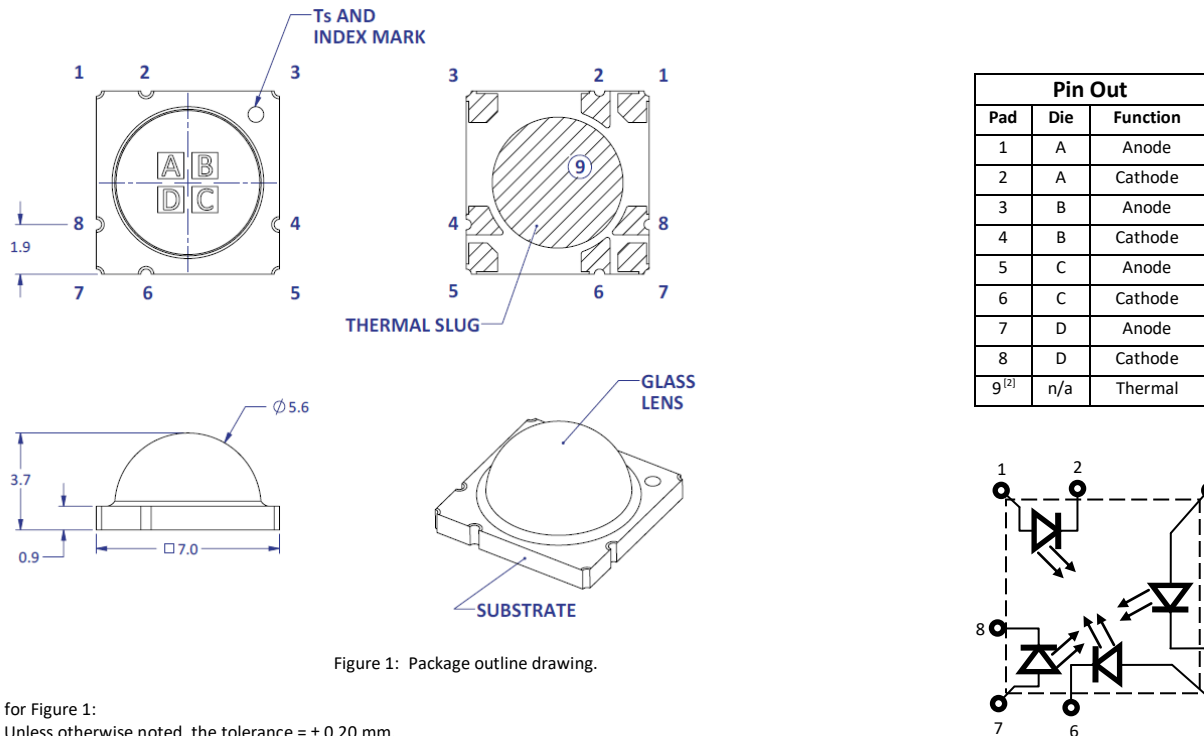

Figure 1: Package outline drawing.

Notes for Figure 1:

1. Unless otherwise noted, the tolerance =  $\pm 0.20$  mm.
2. Thermal contact, Pad 9, is electrically neutral.

## Recommended Solder Pad Layout (mm)

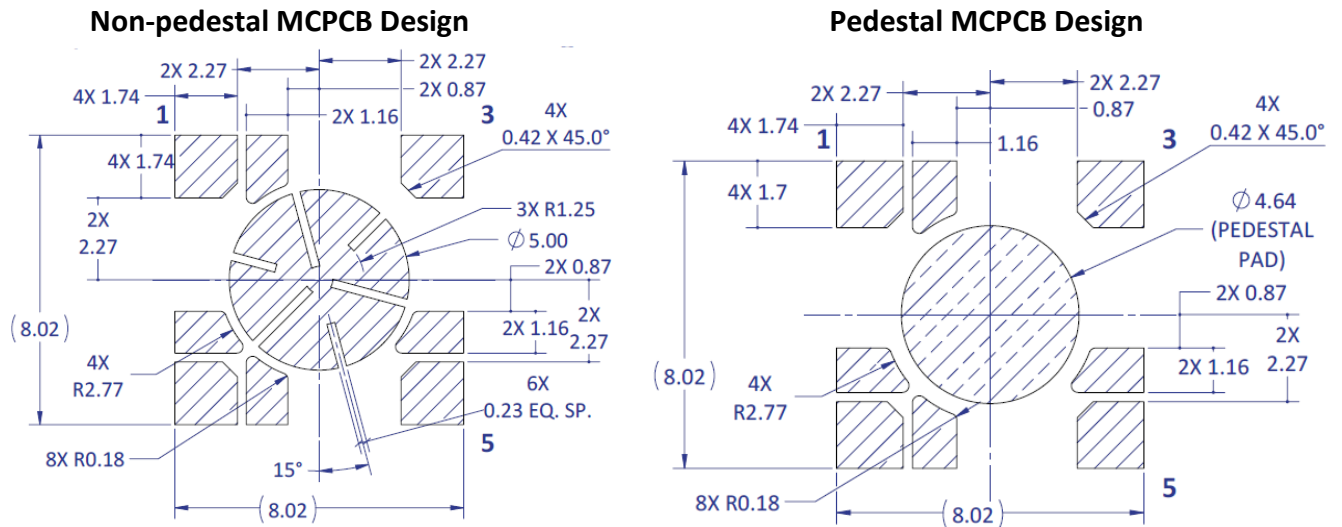

Figure 2a: Recommended solder pad layout for anode, cathode, and thermal pad for non-pedestal and pedestal design

Note for Figure 2a:

1. Unless otherwise noted, the tolerance =  $\pm 0.20$  mm.
2. Pedestal MCPCB allows the emitter thermal slug to be soldered directly to the metal core of the MCPCB. Such MCPCB eliminate the high thermal resistance dielectric layer that standard MCPCB technologies use in between the emitter thermal slug and the metal core of the MCPCB, thus lowering the overall system thermal resistance.
3. LED Engin recommends x-ray sample monitoring for solder voids underneath the emitter thermal slug. The total area covered by solder voids should be less than 20% of the total emitter thermal slug area. Excessive solder voids will increase the emitter to MCPCB thermal resistance and may lead to higher failure rates due to thermal over stress.

## Recommended Solder Mask Layout (mm)



Figure 2b: Recommended solder mask opening for anode, cathode, and thermal pad for non-pedestal and pedestal design

Note for Figure 2b:

1. Unless otherwise noted, the tolerance =  $\pm 0.20$  mm.

## Recommended 8 mil Stencil Apertures Layout (mm)

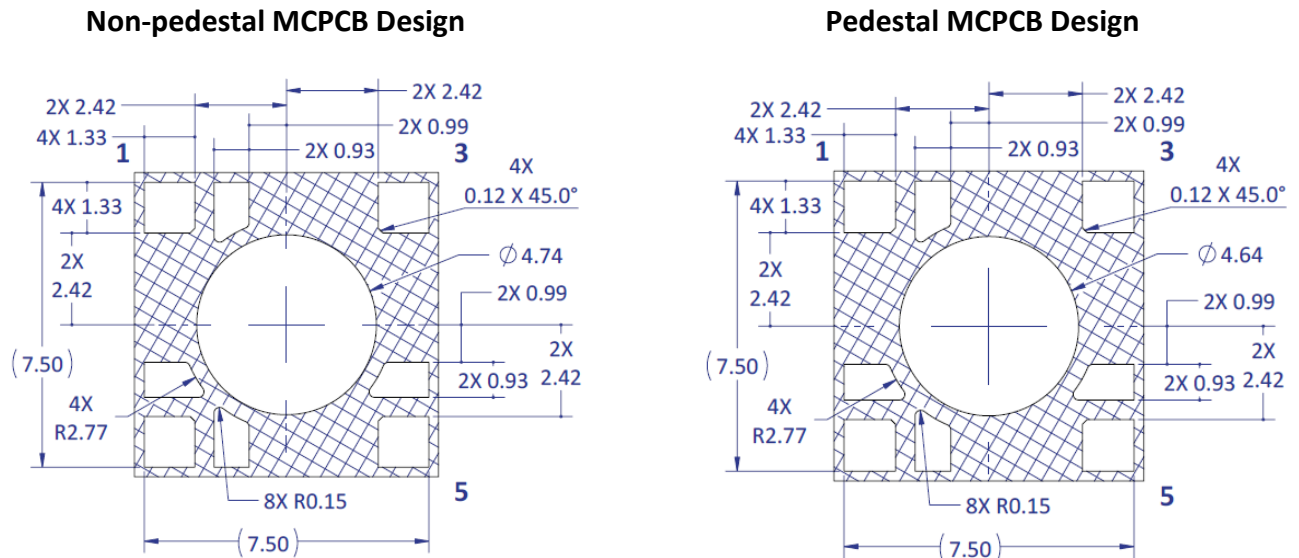

Figure 2c: Recommended 8mil stencil apertures for anode, cathode, and thermal pad for non-pedestal and pedestal design

Note for Figure 2c:

1. Unless otherwise noted, the tolerance =  $\pm 0.20$  mm.

## Reflow Soldering Profile



Figure 3: Reflow soldering profile for lead free soldering.

## Typical Radiation Pattern

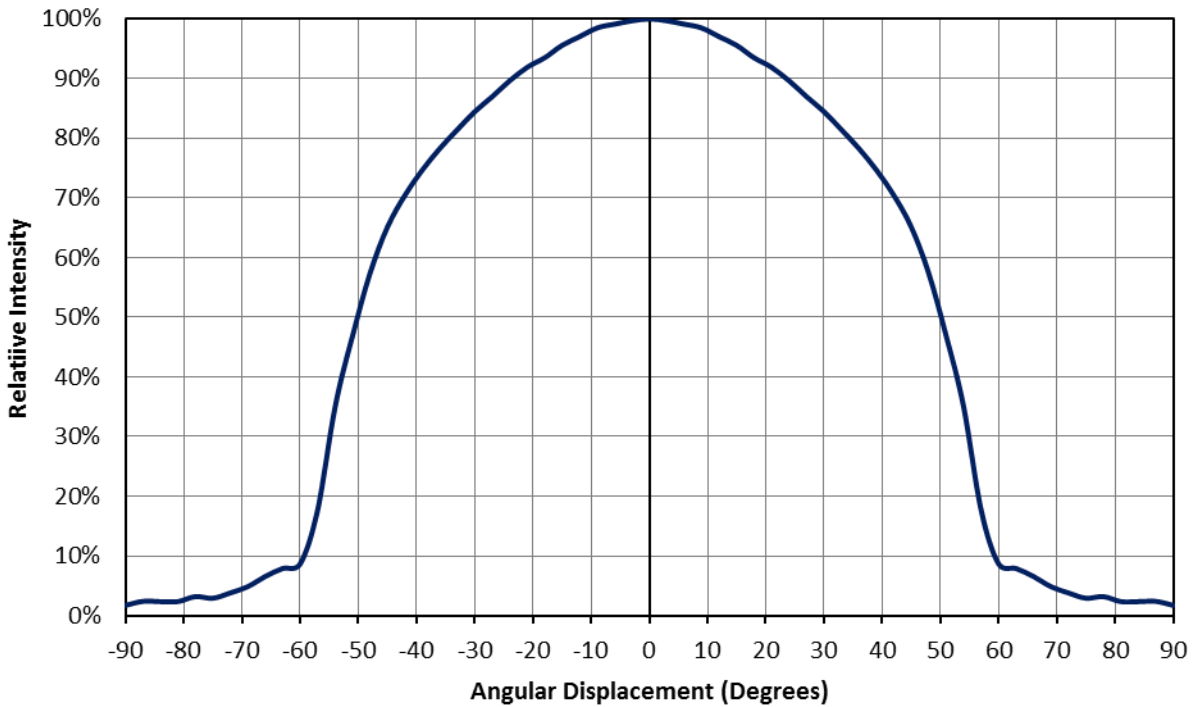

Figure 4: Typical representative spatial radiation pattern.



### Typical Relative Spectral Power Distribution

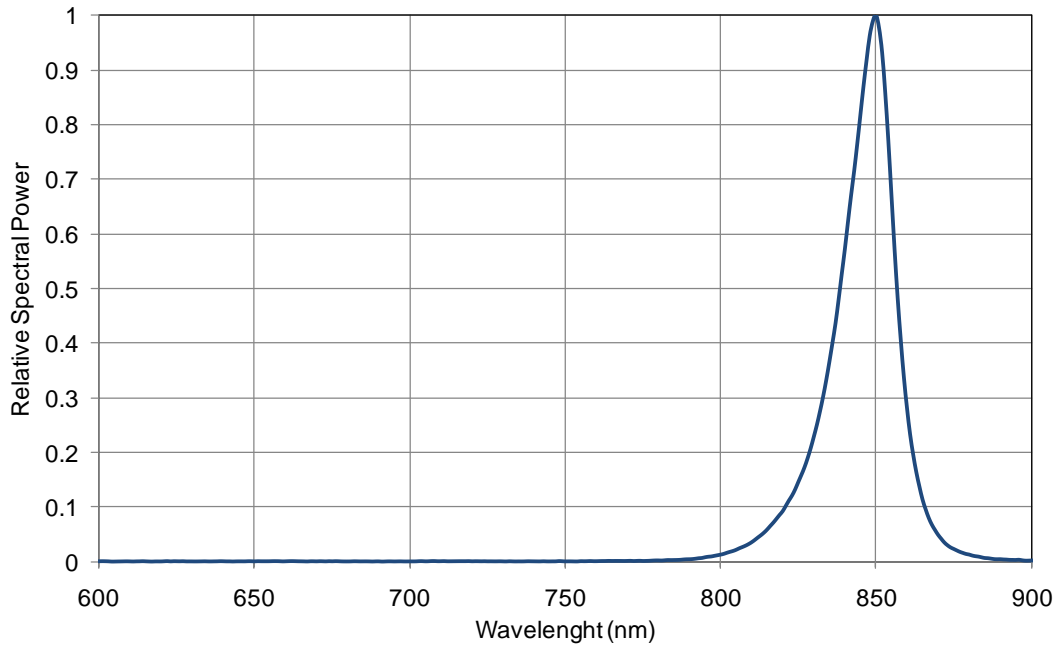

Figure 5: Relative spectral power vs. wavelength @ T<sub>c</sub> = 25°C.

### Typical Forward Current Characteristics

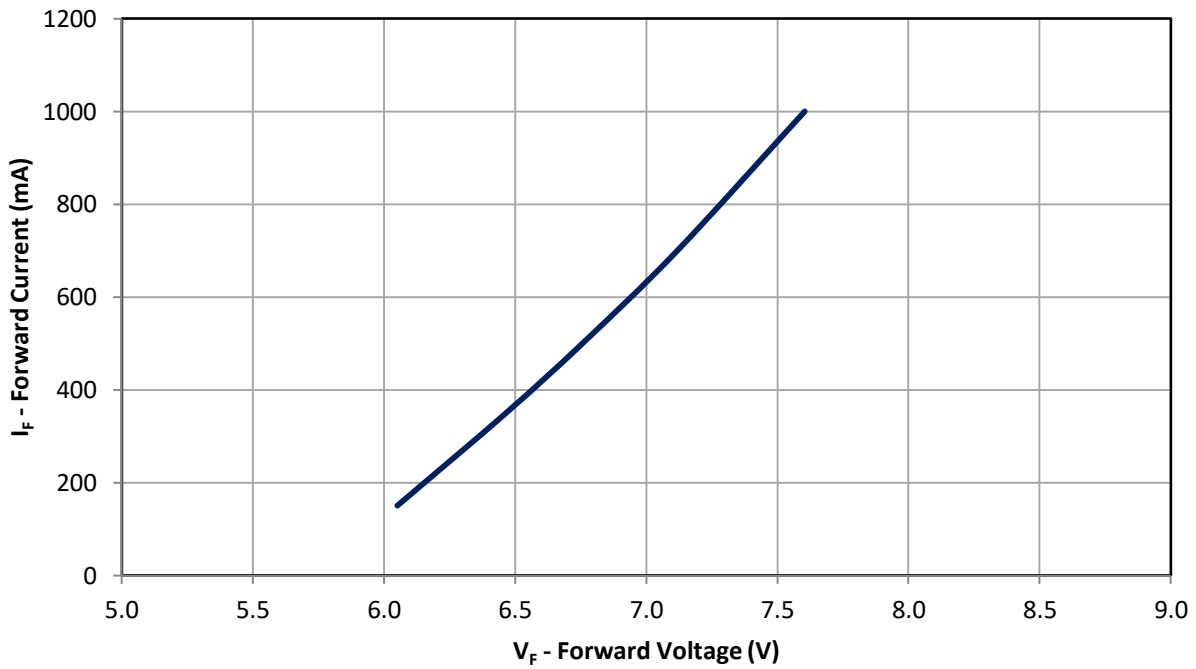

Figure 6: Typical forward current vs. forward voltage @ T<sub>c</sub> = 25°C.

Notes:

1. Forward Voltage curve assumes that all four LED dice are connected in series.

### Typical Normalized Radiant Flux over Current

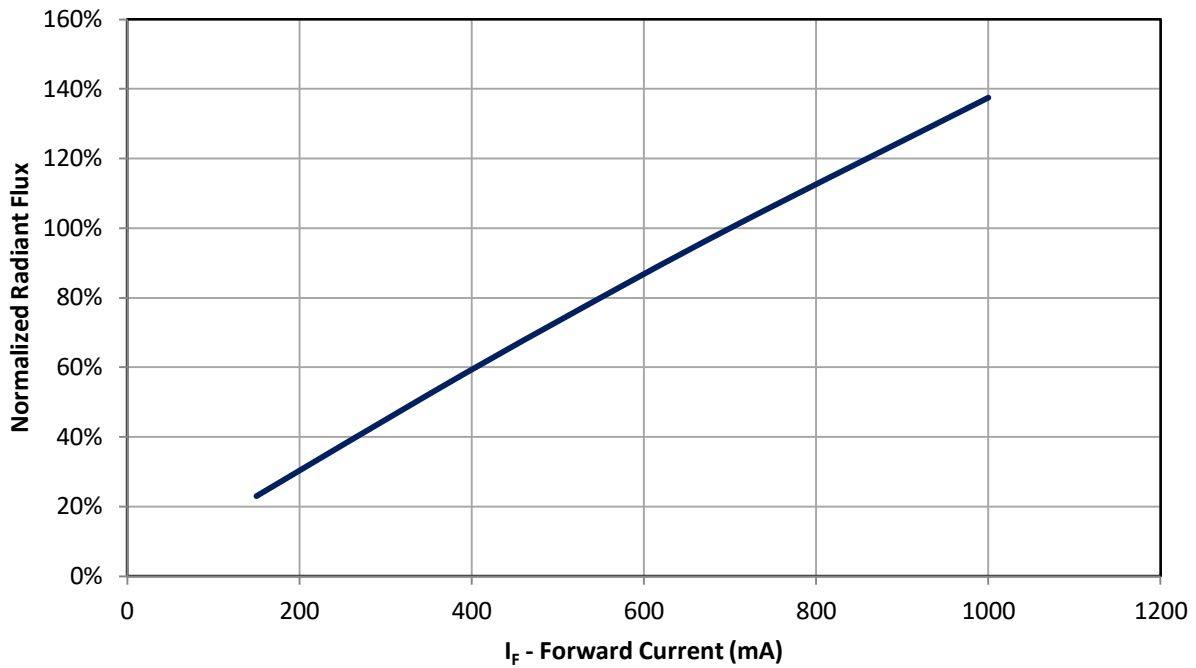

Figure 7: Typical normalized radiant flux vs. forward current @  $T_c = 25^\circ\text{C}$ .

### Typical Normalized Radiant Flux over Temperature

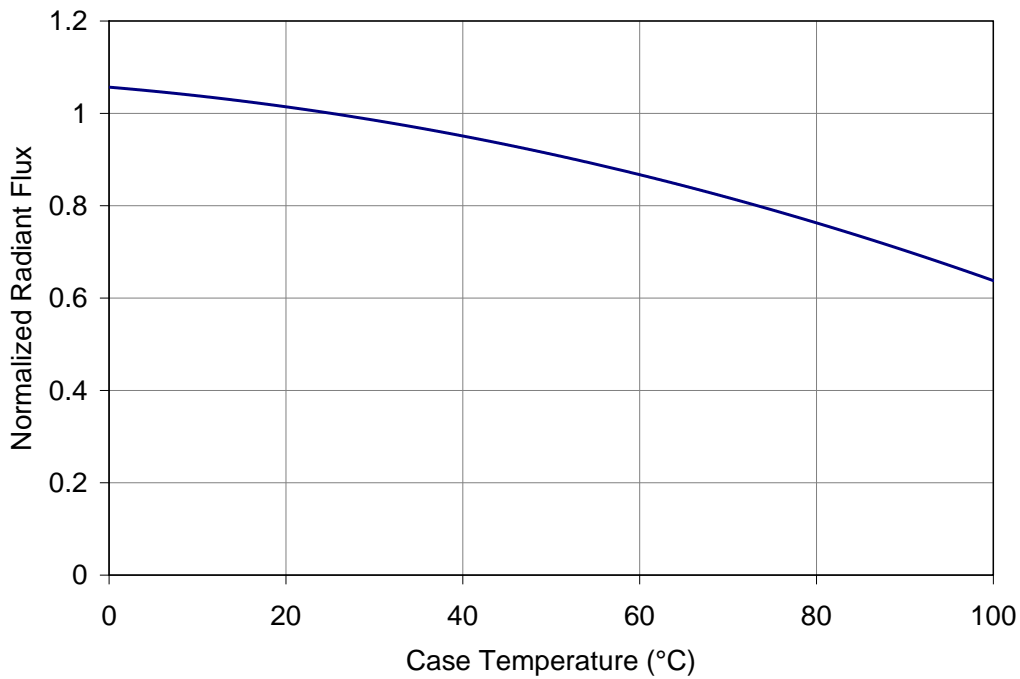

Figure 8: Typical normalized radiant flux vs. case temperature.

### Typical Peak Wavelength Shift over Current

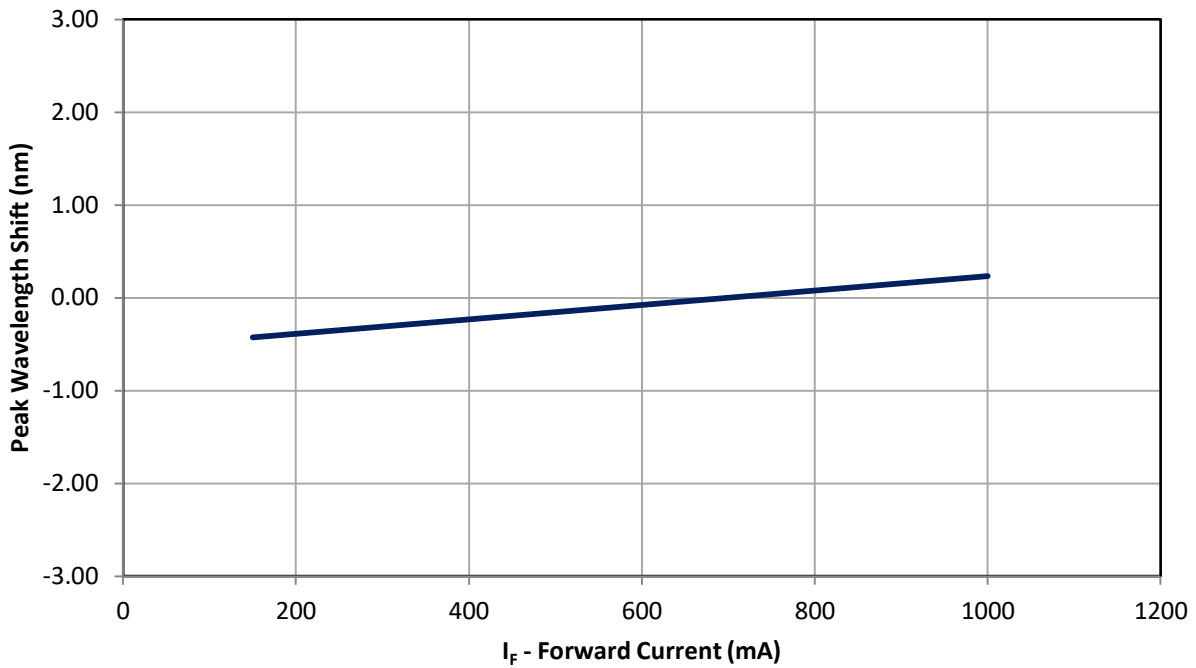

Figure 9: Typical peak wavelength shift vs. forward current @ Tc = 25°C

### Typical Peak Wavelength Shift over Temperature

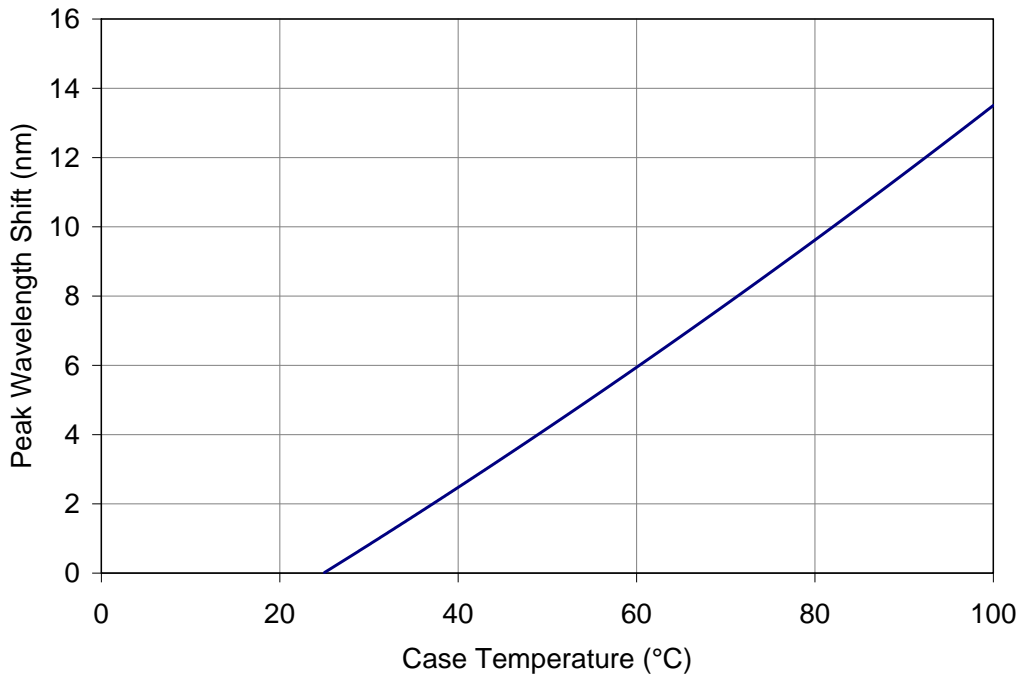

Figure 10: Typical peak wavelength shift vs. case temperature.

## Current De-rating

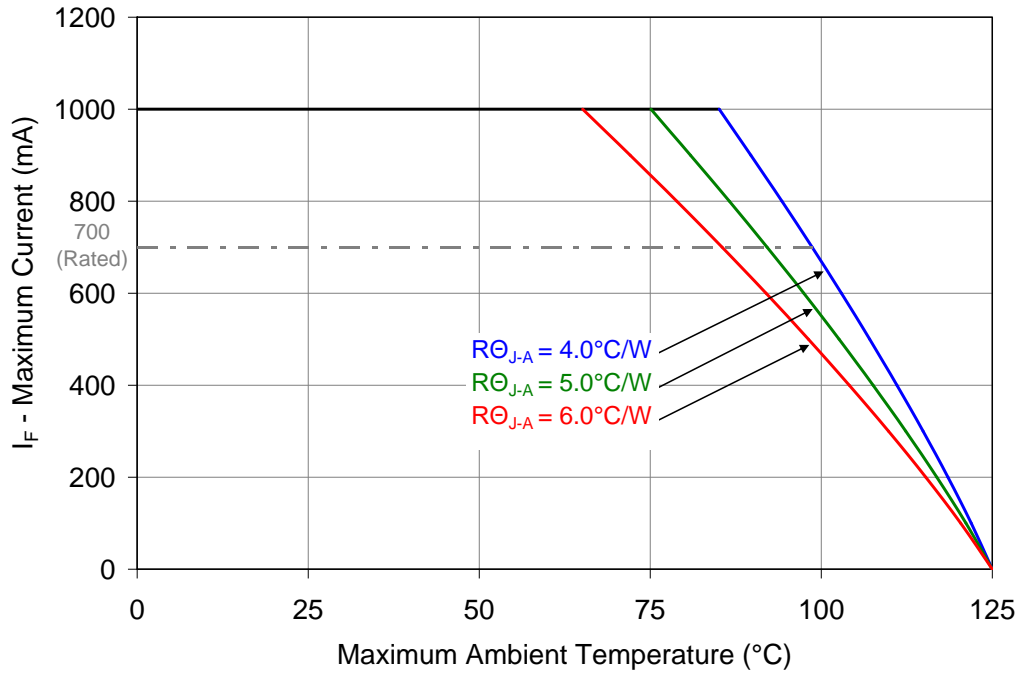

Figure 11: Maximum forward current vs. ambient temperature based on  $T_{J(\text{MAX})} = 125^\circ\text{C}$ .

Notes:

1. Maximum current assumes that all four LED dice are operating concurrently at the same current.
2.  $RO_{J-C}$  [Junction to Case Thermal Resistance] for the LZ4-00R408 is typically  $2.8^\circ\text{C/W}$ .
3.  $RO_{J-A}$  [Junction to Ambient Thermal Resistance] =  $RO_{J-C} + RO_{C-A}$  [Case to Ambient Thermal Resistance].

## Emitter Tape and Reel Specifications (mm)

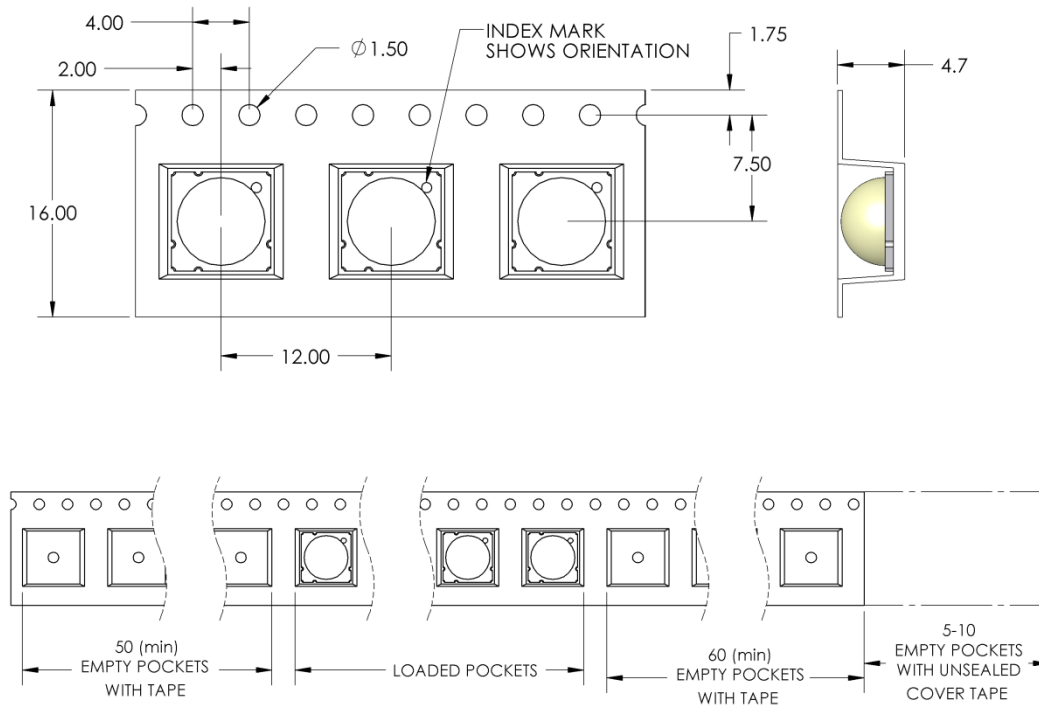

Figure 12: Emitter carrier tape specifications (mm).



Figure 13: Emitter Reel specifications (mm).

Notes:

1. Reel quantity minimum: 100 emitters. Reel quantity maximum: 1200 emitters.

# LZ4 MCPCB Family

Part number	Type of MCPCB	Diameter (mm)	Emitter + MCPCB Thermal Resistance (°C/W)	Typical $V_f$ (V)	Typical $I_f$ (mA)
LZ4-4xxxxxx	1-channel	19.9	2.8 + 1.1 = 3.9	7.4	700

## Mechanical Mounting of MCPCB

- MCPCB bending should be avoided as it will cause mechanical stress on the emitter, which could lead to substrate cracking and subsequently LED dies cracking.
- To avoid MCPCB bending:
  - Special attention needs to be paid to the flatness of the heat sink surface and the torque on the screws.
  - Care must be taken when securing the board to the heat sink. This can be done by tightening three M3 screws (or #4-40) in steps and not all the way through at once. Using fewer than three screws will increase the likelihood of board bending.
  - It is recommended to always use plastics washers in combinations with the three screws.
  - If non-taped holes are used with self-tapping screws, it is advised to back out the screws slightly after tightening (with controlled torque) and then re-tighten the screws again.

## Thermal interface material

- To properly transfer heat from LED emitter to heat sink, a thermally conductive material is required when mounting the MCPCB on to the heat sink.
- There are several varieties of such material: thermal paste, thermal pads, phase change materials and thermal epoxies. An example of such material is Electrolube EHTC.
- It is critical to verify the material's thermal resistance to be sufficient for the selected emitter and its operating conditions.

## Wire soldering

- To ease soldering wire to MCPCB process, it is advised to preheat the MCPCB on a hot plate of 125-150°C. Subsequently, apply the solder and additional heat from the solder iron will initiate a good solder reflow. It is recommended to use a solder iron of more than 60W.
- It is advised to use lead-free, no-clean solder. For example: SN-96.5 AG-3.0 CU 0.5 #58/275 from Kester (pn: 24-7068-7601)

# LZ4-4xxxxx

## 1 channel, Standard Star MCPCB (1x4) Dimensions (mm)

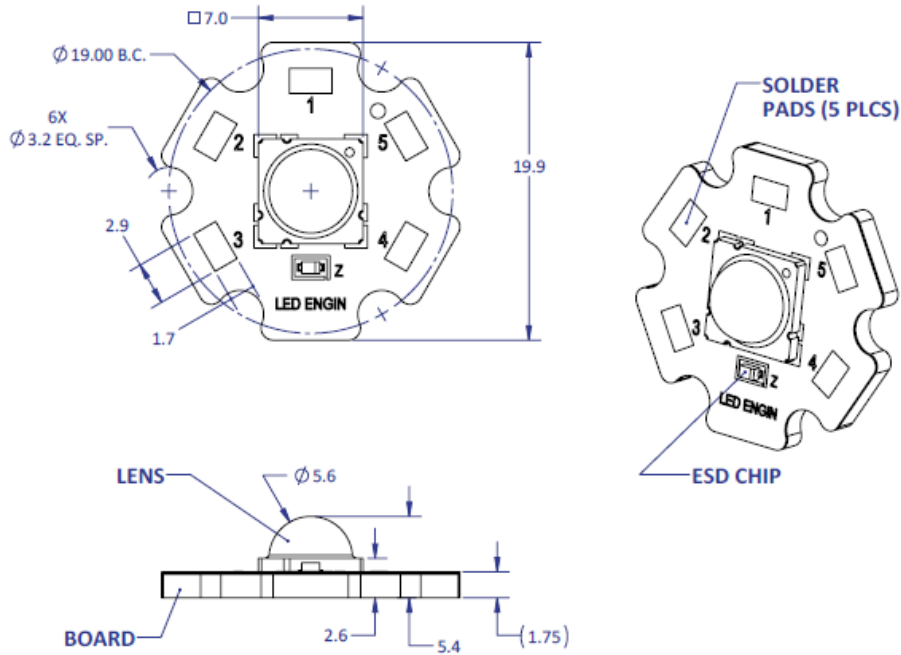

**Notes:**

- Unless otherwise noted, the tolerance = ± 0.2 mm.
- Slots in MCPCB are for M3 or #4-40 mounting screws.
- LED Engin recommends plastic washers to electrically insulate screws from solder pads and electrical traces.
- LED Engin recommends thermal interface material when attaching the MCPCB to a heatsink
- The thermal resistance of the MCPCB is: R<sub>ΘC-B</sub> 1.1°C/W

### Components used

MCPCB: HT04503 (Bergquist)  
 ESD chips: BZX585-C30 (NXP, for 4 LED dies in series)

Pad layout			
Ch.	MCPCB Pad	String/die	Function
1	1, 2, 3 4, 5	1/ABCD	Cathode - Anode +

## Company Information

LED Engin, Inc., based in California’s Silicon Valley, specializes in ultra-bright, ultra compact solid state lighting solutions allowing lighting designers & engineers the freedom to create uncompromised yet energy efficient lighting experiences. The LuxiGen™ Platform — an emitter and lens combination or integrated module solution, delivers superior flexibility in light output, ranging from 3W to 90W, a wide spectrum of available colors, including whites, multi-color and UV, and the ability to deliver upwards of 5,000 high quality lumens to a target. The small size combined with powerful output allows for a previously unobtainable freedom of design wherever high-flux density, directional light is required. LED Engin’s packaging technologies lead the industry with products that feature lowest thermal resistance, highest flux density and consummate reliability, enabling compact and efficient solid state lighting solutions.

LED Engin is committed to providing products that conserve natural resources and reduce greenhouse emissions.

LED Engin reserves the right to make changes to improve performance without notice.

Please contact [sales@ledengin.com](mailto:sales@ledengin.com) or (408) 922-7200 for more information.