

Description

The XUL is an Ultra Precision LVDS crystal oscillator with 300fs typical phase jitter over 12kHz to 20MHz bandwidth. Available in a wide frequency range from 16kHz to 1500MHz, the IDT XUL series crystal oscillator utilizes a family of proprietary ASICs, with a key focus on noise reduction technologies.

The 4th order Delta Sigma Modulator reduces noise to the levels that are comparable to traditional bulk Quartz and SAW oscillators. With short lead-time, low cost, low noise, wide frequency range, excellent ambient performance, the XUL is an excellent choice over the conventional technologies. The XUL has stabilities as tight as $\pm 20\text{ppm}$ with extremely quick delivery for both standard and custom frequencies

Features

- Frequency range: 0.016 to 1500MHz
- Output type: LVDS
- Frequency stability: $\pm 20\text{ppm}$, $\pm 25\text{ppm}$, $\pm 50\text{ppm}$, or $\pm 100\text{ppm}$
- Supply voltage: 1.8V, 2.5V, or 3.3V
- Phase jitter (1.875MHz to 20MHz): 100fs typical
- Phase jitter (12kHz to 20MHz): 300fs typical
- Package options: 5.0mm x 3.2mm x 1.2mm (JS6)
7.0mm x 5.0mm x 1.3mm (JU6)
- Operating temperatures: -20°C to $+70^{\circ}\text{C}$ or -40°C to $+85^{\circ}\text{C}$

Pin Assignment

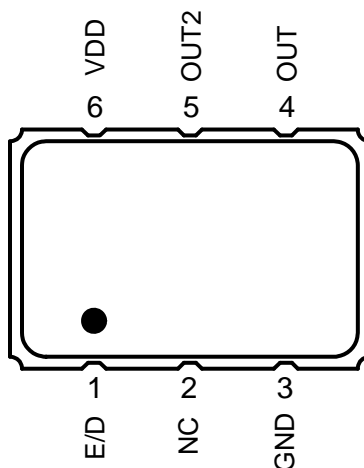

6-pin CLCC

Pin Descriptions

Pin Number	Pin Name	Description
1	E/D	Enable/Disable ¹ (0 = Output Disabled)
2	NC	No connect
3	GND	Connect to ground
4	OUT	Output
5	OUT2	Complementary output
6	VDD	Supply Voltage

1. Pulled high internally.

Absolute Maximum Ratings

Stresses above the ratings listed below can cause permanent damage to the XUL. These ratings, which are standard values for IDT commercially rated parts, are stress ratings only. Functional operation of the device at these or any other conditions above those indicated in the operational sections of the specifications is not implied. Exposure to absolute maximum rating conditions for extended periods can affect product reliability. Electrical parameters are guaranteed only over the recommended operating temperature range.

Item	Rating
VDD	-0.5 to +5.0V
E/D	-0.5V to VDD + 0.5V
OUT	-0.5V to VDD + 0.5V
Storage Temperature	-55°C to 125°C
Theta Ja (Junction to Ambient)	102°C/W – Still Air

ESD Compliance

Human Body Model (HBM)	1000V
Machine Model (MM)	150V

Mechanical Testing

Parameter	Test Method
Mechanical Shock	Half-Sine wave with 0.3ms 3000G X, Y, Z each direction 1 time
Mechanical Vibration	Frequency: 10 to 55 MHz Amplitude: 1.5mm Frequency: 55~2000Hz Peak value: 20G Duration time: 4H for each X,Y,Z axis Total 12hours
High Temp Operating Life (HTOL)	2000 Hours 125°C (under power)
Hermetic Seal	Gross leak (Air leak test) Fine leak (Helium leak test) He-pressure: 6kgf/cm ² 2 hours

Solder Reflow Profile

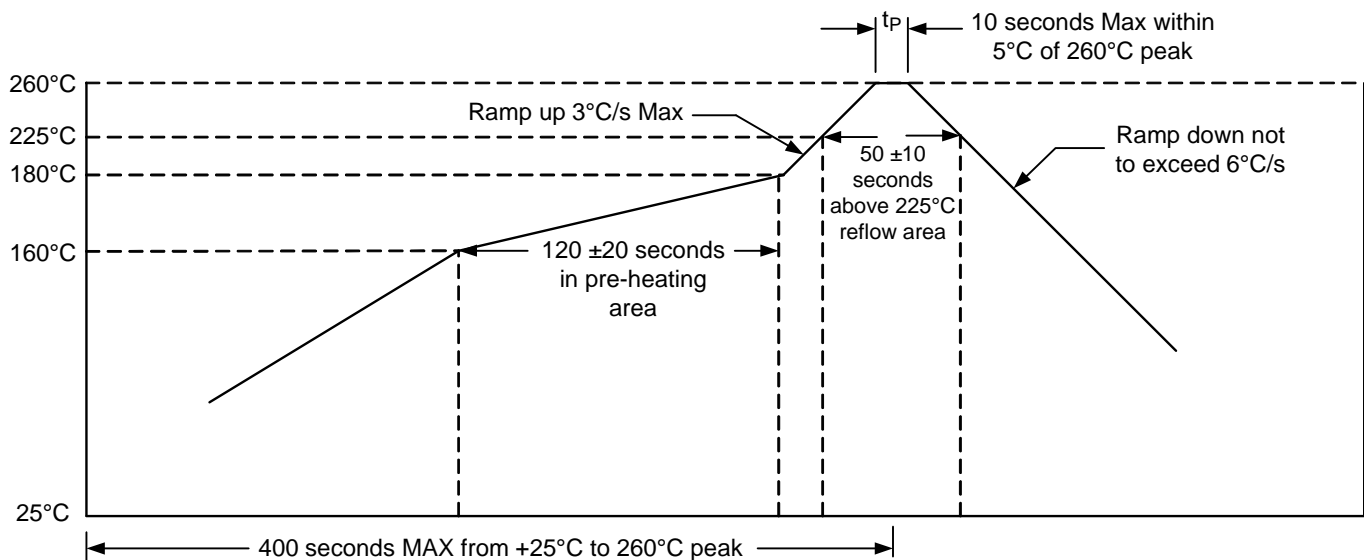

DC Characteristics

($V_{DD} = 3.3V \pm 5\%$, $T_A = -20^\circ C$ to $+70^\circ C$; -40° to $+85^\circ C$). Below are guaranteed for listed standard frequencies.

Parameter	Symbol	Condition	Min	Typ	Max	Units
Power Supply Current	I_{DD}	Standard Frequencies		79	97	mA
Differential Output Voltage	V_{OD}	Std LVDS load	0.25	0.5	0.6	V
Output Offset Voltage	V_{OS}	Std LVDS load	1.0	1.17	1.375	V
Enable/Disable Input HIGH Voltage (Output enabled)*	V_{IH}		$70\%V_{DD}$			V
Enable/Disable Input LOW Voltage (Output disabled)	V_{IL}				$30\%V_{DD}$	V

* A pullup resistor from pin 6 (VDD) to pin 1 (E/D) enables output when pin 1 is left open.

AC Characteristics

($V_{DD} = 3.3V \pm 5\%$, $T_A = -20^\circ C$ to $+70^\circ C$; -40° to $+85^\circ C$). Below are guaranteed for listed standard frequencies.

Parameter	Symbol	Condition	Min	Typ	Max	Units
Output Frequency Range	F_{OUTR}		0.016		1500	MHz
Frequency Stability		Temperature = $-20^\circ C$ to $+70^\circ C$	± 20		± 100	ppm
		Temperature = $-40^\circ C$ to $+85^\circ C$	± 25		± 100	ppm
Aging (1 st year)		$T_a = 25^\circ C$			± 3	
Aging (10 years)		$T_a = 25^\circ C$			± 10	
Output Load		Differential		100		Ohms
Start-up Time	T_{ST}	Output valid time after VDD meets minimum specified level			10	ms
Output Rise Time		20% to 80% V_{PP}		275	380	ps
Output Fall Time		80% to 20% V_{PP}		275	380	ps
Output Clock Duty Cycle	T_{DTCY}	At 50% V_{PP}	45		55	%
Output Enable/ Disable Time	T_{OE}				100	ns
Period Jitter, RMS	J_{PER}	Frequency = 156.25MHz		3.5	8	ps
Random Jitter	R_J	Frequency = 156.25MHz		0.9	1.5	ps
Deterministic Jitter	D_J	Per MJSQ spec (Methodologies for Jitter and Signal Quality specifications)		12	26	ps
Total Jitter	T_J			25	44	ps
Phase Jitter (12kHz – 20MHz)	ϕ_{JITTER}	At $25^\circ C$ & 3.3V		300	400	fs
Phase Noise Performance Frequency = 156.25 MHz	ϕ_{NOISE}	100Hz of Carrier		-97		dBc/Hz
		1kHz of Carrier		-112		dBc/Hz
		10kHz of Carrier		-122		dBc/Hz
		100kHz of Carrier		-131		dBc/Hz
		1MHz of Carrier		-146		dBc/Hz
		10MHz of Carrier		-153		dBc/Hz
Output Frequency (Standards)	F_{OUT}	100MHz, 106.25MHz, 125MHz, 150MHz, 155.52MHz, 156.25MHz, 200MHz, 212.5MHz, 250MHz, 300MHz, 312.5MHz, 400MHz (Contact IDT for additional frequencies)				

Note: Inclusive of initial frequency accuracy, operating temperature range, supply variation, load variation, 3 times solder reflow, shock, vibration and 1 year aging at $25^\circ C$. We do not recommend hand soldering the devices

DC Characteristics

($V_{DD} = 2.5V \pm 5\%$, $T_A = -20^\circ C$ to $+70^\circ C$; -40° to $+85^\circ C$). Below are guaranteed for listed standard frequencies.

Parameter	Symbol	Condition	Min	Typ	Max	Units
Power Supply Current	I_{DD}	Standard frequencies		75	90	mA
Differential Output Voltage	V_{OD}	Std LVDS load	0.25	0.45	0.55	V
Output Offset Voltage	V_{OS}	Std LVDS load	1.0	1.17	1.375	V
Enable/Disable Input HIGH Voltage (Output enabled)*	V_{IH}		$70\%V_{DD}$			V
Enable/Disable Input LOW Voltage (Output disabled)	V_{IL}				$30\%V_{DD}$	V

* A pullup resistor from pin 6 (VDD) to pin 1 (E/D) enables output when pin 1 is left open.

AC Characteristics

($V_{DD} = 2.5V \pm 5\%$, $T_A = -20^\circ C$ to $+70^\circ C$; -40° to $+85^\circ C$). Below are guaranteed for listed standard frequencies.

Parameter	Symbol	Condition	Min	Typ	Max	Units
Output Frequency Range	F_{OUTR}		0.016		1350	MHz
Frequency Stability		Temperature = $-20^\circ C$ to $+70^\circ C$	± 20		± 100	ppm
		Temperature = $-40^\circ C$ to $+85^\circ C$	± 25		± 100	ppm
Output Load		Differential		100		Ohms
Start-up Time	T_{ST}	Output valid time after VDD meets minimum specified level			10	ms
Output Rise Time		20% to 80% V_{PP}		300	400	ps
Output Fall Time		80% to 20% V_{PP}		300	400	ps
Output Clock Duty Cycle	T_{DTCY}	At 50% V_{PP}	45		55	%
Output Enable/ Disable Time	T_{OE}				100	ns
Period Jitter, RMS	J_{PER}	Frequency = 156.25MHz		5	9	ps
Random Jitter	R_J	Frequency = 156.25MHz		0.9	1.3	ps
Deterministic Jitter	D_J	Per MJSQ spec (Methodologies for Jitter and Signal Quality specifications)		10	18	ps
Total Jitter	T_J			25	36	ps
Phase Jitter (12kHz – 20MHz)	ϕ_{JITTER}	At $25^\circ C$ & 2.5V		400	500	fs
Phase Noise Performance Frequency = 156.25MHz	ϕ_{NOISE}	100Hz of Carrier		-97		dBc/Hz
		1kHz of Carrier		-114		dBc/Hz
		10kHz of Carrier		-120		dBc/Hz
		100kHz of Carrier		-127		dBc/Hz
		1MHz of Carrier		-146		dBc/Hz
		10MHz of Carrier		-153		dBc/Hz
Output Frequency (Standards)	F_{OUT}	100MHz, 106.25MHz, 125MHz, 150MHz, 155.52MHz, 156.25MHz, 200MHz, 212.5MHz, 250MHz, 300MHz, 312.5MHz, 400MHz (Contact IDT for additional frequencies)				

Note: Inclusive of initial frequency accuracy, operating temperature range, supply variation, load variation, 3 times solder reflow, shock, vibration and 1 year aging at $25^\circ C$. We do not recommend hand soldering the devices

DC Characteristics

($V_{DD} = 1.8V \pm 5\%$, $T_A = -20^\circ C$ to $+70^\circ C$; -40° to $+85^\circ C$). Below are guaranteed for listed standard frequencies.

Parameter	Symbol	Condition	Min	Typ	Max	Units
Power Supply Current	I_{DD}	Standard frequencies			65	mA
Differential Output Voltage	V_{OD}	Std LVDS load	0.25	0.4	0.5	V
Output Offset Voltage	V_{OS}	Std LVDS load		1.17		V
Enable/Disable Input HIGH Voltage (Output enabled)*	V_{IH}		$70\%V_{DD}$			V
Enable/Disable Input LOW Voltage (Output disabled)	V_{IL}				$30\%V_{DD}$	V

* A pullup resistor from pin 6 (VDD) to pin 1 (E/D) enables output when pin 1 is left open.

AC Characteristics

($V_{DD} = 1.8V \pm 5\%$, $T_A = -20^\circ C$ to $+70^\circ C$; -40° to $+85^\circ C$). Below are guaranteed for listed standard frequencies.

Parameter	Symbol	Condition	Min	Typ	Max	Units
Output Frequency Range	F_{OUTR}		0.016		1000	MHz
Frequency Stability		Temperature = $-20^\circ C$ to $+70^\circ C$	± 20		± 100	ppm
		Temperature = $-40^\circ C$ to $+85^\circ C$	± 25		± 100	ppm
Output Load		Differential		100		Ohms
Start-up Time	T_{ST}	Output valid time after VDD meets minimum specified level			10	ms
Output Rise Time		20% to 80% V_{PP}		250	315	ps
Output Fall Time		80% to 20% V_{PP}		250	315	ps
Output Clock Duty Cycle	T_{DTCY}	$\leq 156.25MHz$	45		55	%
		$> 156.25MHz$	40		60	%
Output Enable/ Disable Time	T_{OE}				100	ns
Period Jitter, RMS	J_{PER}	Frequency = 156.25MHz		5	10	ps
Random Jitter	R_J	Frequency = 156.25MHz		2.0	3.8	ps
Deterministic Jitter	D_J	Per MJSQ spec (Methodologies for Jitter and Signal Quality specifications)		27	36	ps
Total Jitter	T_J			60	80	ps
Phase Jitter (12kHz – 20MHz)	ϕ_{JITTER}	At $25^\circ C$ & 1.8V		800	1200	fs
Phase Noise Performance Frequency = 156.25MHz	ϕ_{NOISE}	100Hz of Carrier		-91		dBc/Hz
		1kHz of Carrier		-107		dBc/Hz
		10kHz of Carrier		-111		dBc/Hz
		100kHz of Carrier		-121		dBc/Hz
		1MHz of Carrier		-143		dBc/Hz
		10MHz of Carrier		-147		dBc/Hz
Output Frequency (Standards)	F_{OUT}	100MHz, 106.25MHz, 125MHz, 150MHz, 155.52MHz, 156.25MHz, 200MHz, 212.5MHz, 250MHz, 300MHz, 312.5MHz, 400MHz (Contact IDT for additional frequencies)				

Note: Inclusive of initial frequency accuracy, operating temperature range, supply variation, load variation, 3 times solder reflow, shock, vibration and 1 year aging at $25^\circ C$. We do not recommend hand soldering the devices

Output Waveform

Output Levels/Rise Time/Fall Time Measurements

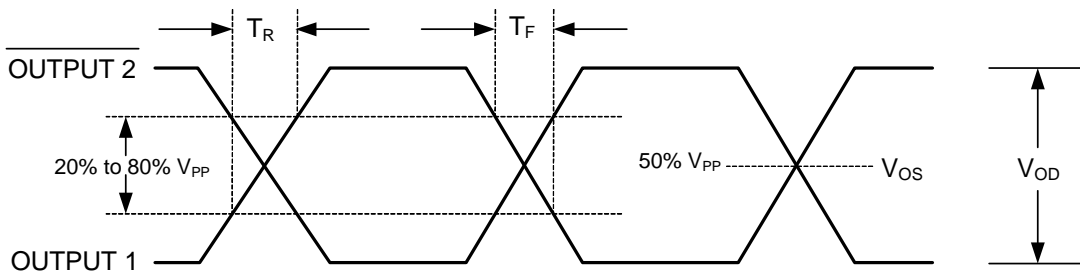

Oscillator Symmetry

Ideally, Symmetry should be 50/50 for 1/2 period –Other expressions are 45/55 or 55/45

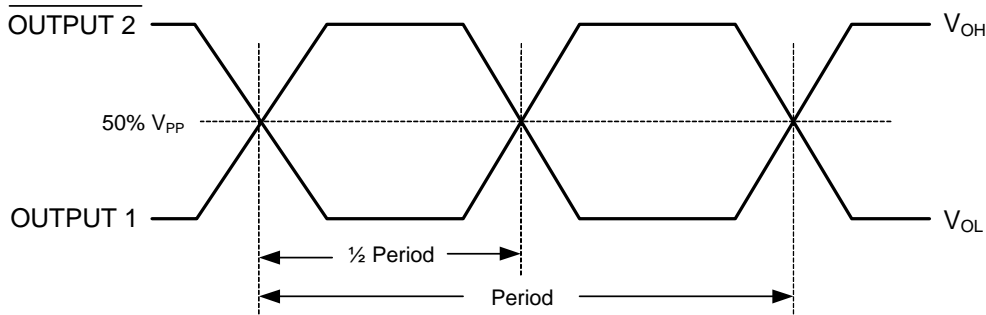

Typical Phase Noise

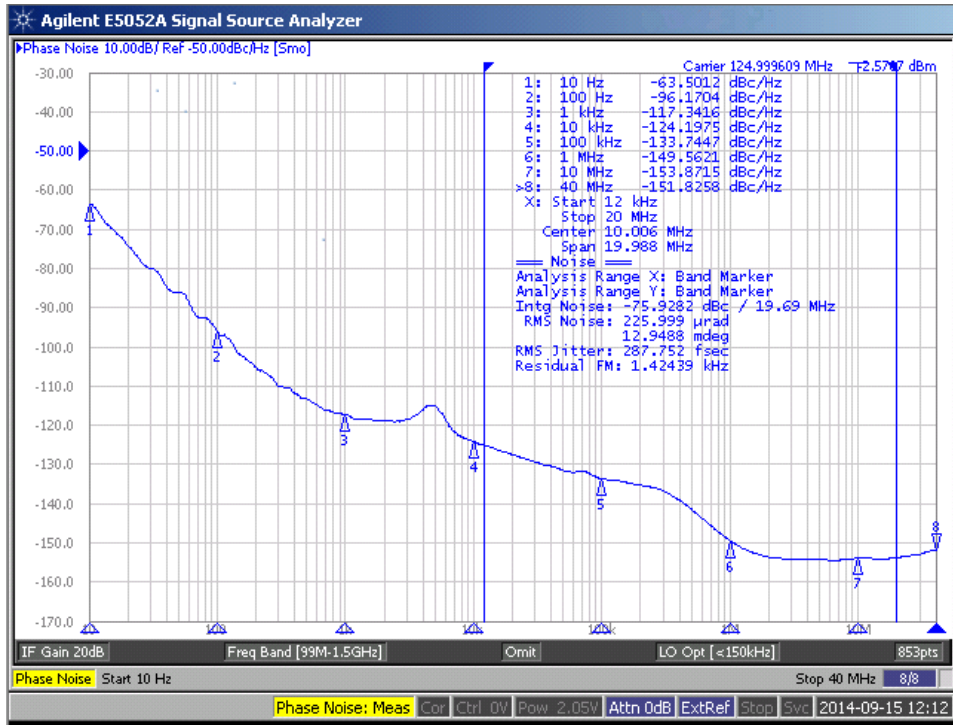

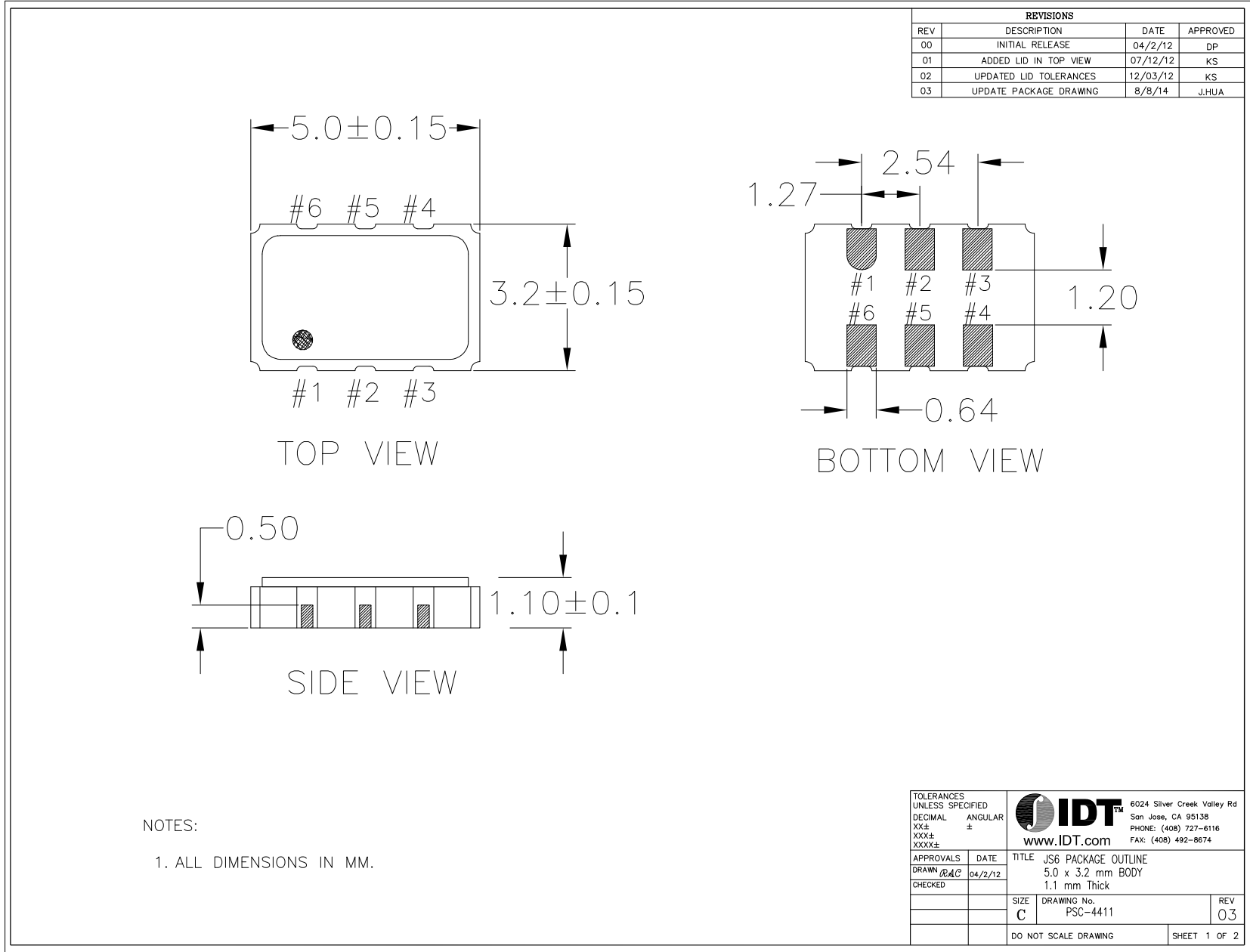

JS6 Package Outline and Dimensions (cont.)

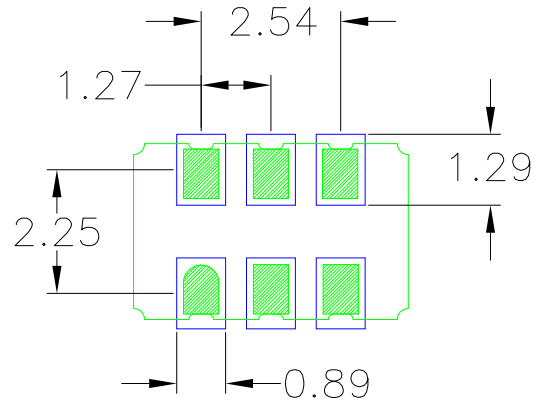

RECOMMENDED LAND PATTERN

NOTES:

1. ALL DIMENSION ARE IN mm. ANGLES IN DEGREES.
2. TOP DOWN VIEW. AS VIEWED ON PCB.
3. COMPONENT OUTLINE SHOW FOR REFERENCE IN GREEN.
4. LAND PATTERN IN BLUE. NSMD PATTERN ASSUMED.
5. LAND PATTERN RECOMMENDATION PER IPC-7351B GENERIC REQUIREMENT FOR SURFACE MOUNT DESIGN AND LAND PATTERN.

REVISIONS			
REV	DESCRIPTION	DATE	APPROVED
00	INITIAL RELEASE	04/2/12	DP
01	ADDED LID IN TOP VIEW	07/12/12	KS
02	UPDATED LID TOLERANCES	12/03/12	KS
03	UPDATE PACKAGE DRAWING	8/8/14	J.HUA

TOLERANCES UNLESS SPECIFIED DECIMAL ANGULAR XX± ± XXX± ± XXXX± ±		6024 Silver Creek Valley Rd San Jose, CA 95138 www.IDT.com PHONE: (408) 727-6116 FAX: (408) 492-8674
APPROVALS	DATE	
DRAWN <i>rac</i>	04/2/12	TITLE JS6 PACKAGE OUTLINE 5.0 x 3.2 mm BODY 1.1 mm Thick
CHECKED		SIZE C DRAWING No. PSC-4411 REV 03
DO NOT SCALE DRAWING		SHEET 2 OF 2

JU6 Package Outline and Dimensions

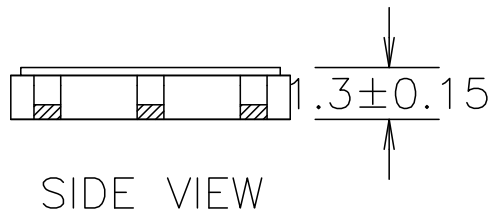
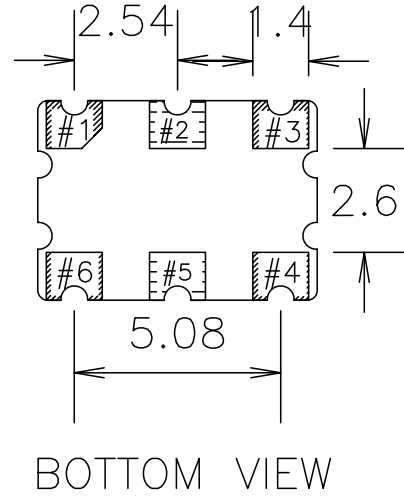
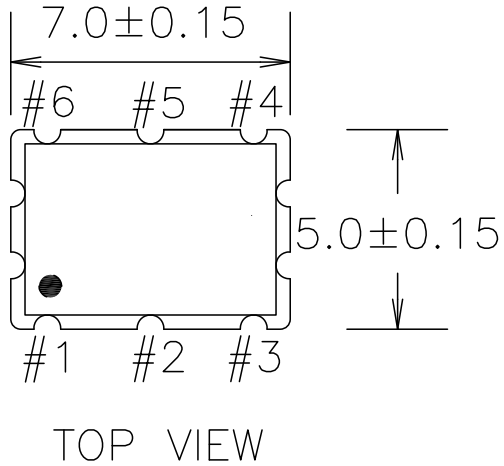

REVISIONS			
REV	DESCRIPTION	DATE	APPROVED
00	INITIAL RELEASE	10/5/12	KS
01	UPDATE PACKAGE DRAWING	8/12/14	J.HUA

NOTES:
1. ALL DIMENSIONS IN MM.

TOLERANCES UNLESS SPECIFIED DECIMAL ANGULAR XX± ± XXX± ° XXXX±		6024 Silver Creek Valley Rd San Jose, CA 95138 PHONE: (408) 727-6116 FAX: (408) 492-8674 www.IDT.com
APPROVALS	DATE	
DRAWN <i>ycs</i>	10/03/12	TITLE: JU6 PACKAGE OUTLINE 7.0 x 5.0 mm BODY 1.3 mm Thick
CHECKED		SIZE: C DRAWING No. PSC-4430 REV 01
DO NOT SCALE DRAWING		SHEET 1 OF 2

JU6 Package Outline and Dimensions (cont.)

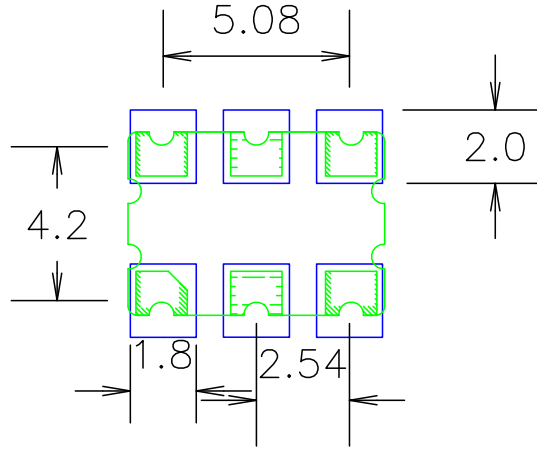

RECOMMENDED LAND PATTERN

NOTES:

1. ALL DIMENSION ARE IN mm. ANGLES IN DEGREES.
2. TOP DOWN VIEW, AS VIEWED ON PCB.
3. COMPONENT OUTLINE SHOW FOR REFERENCE IN GREEN.
4. LAND PATTERN IN BLUE. NSMD PATTERN ASSUMED.
5. LAND PATTERN RECOMMENDATION PER IPC-7351B GENERIC REQUIREMENT FOR SURFACE MOUNT DESIGN AND LAND PATTERN.

REVISIONS			
REV	DESCRIPTION	DATE	APPROVED
00	INITIAL RELEASE	10/5/12	KS
01	UPDATE PACKAGE DRAWING	8/12/14	J.HUA

TOLERANCES UNLESS SPECIFIED			6024 Silver Creek Valley Rd San Jose, CA 95138 PHONE: (408) 727-6116 FAX: (408) 492-8674	
DECIMAL	ANGULAR		www.IDT.com	
XX±	±	APPROVALS		
XXX±		DATE		
XXXX±		TITLE JU6 PACKAGE OUTLINE		
XXXX±		DRAWN 10/03/12		
		7.0 x 5.0 mm BODY		
		1.3 mm Thick		
		SIZE	DRAWING No.	REV
		C	PSC-4430	01
DO NOT SCALE DRAWING				SHEET 2 OF 2

IDT Ordering Information

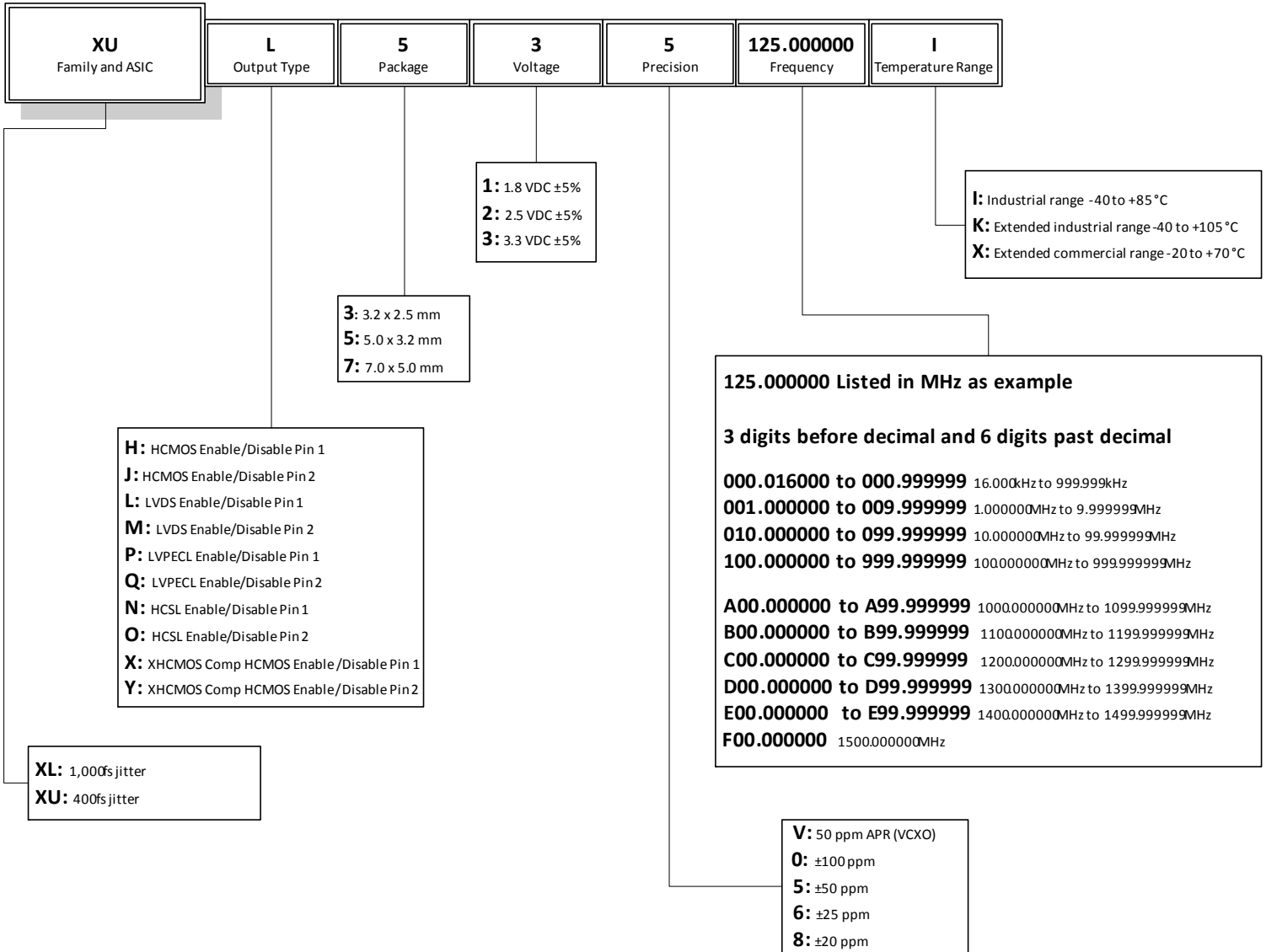

Revision History

Date	Originator	Description of Change
10/01/14	B. Chandhoke	1. Corrected typo in spec for Enable/Disable Low Voltage; from $\geq 30\%VDD$ to $\leq 30\%VDD$. 2. Moved from Advance to Preliminary.
12/15/14	B. Chandhoke	1. Added 7 x 5 x 1.3mm JU6 package option and package dimension/landing pattern drawings. 2. Updates to all DC char tables. 3. Updates to all AC char tables. 4. Updates to Output Waveform diagram. 5. Updated ordering information table/graphic to show JU6 package option.
10/28/16	P. Jenkins	Update ordering information decoder tables by separating them into Scheme 1 and Scheme 2; add note to distinguish the two tables.
06/13/17	L.S.	Removed "Ordering Information Scheme #1 (for reference only)". Replaced with a single ordering information table.
06/20/17	L.S.	Corrected frequency errors in Ordering Information table.



Corporate Headquarters
6024 Silver Creek Valley Road
San Jose, CA 95138 USA
www.IDT.com

Sales
1-800-345-7015 or 408-284-8200
Fax: 408-284-2775
www.IDT.com/go/sales

Tech Support
www.IDT.com/go/support

DISCLAIMER Integrated Device Technology, Inc. (IDT) and its affiliated companies (herein referred to as "IDT") reserve the right to modify the products and/or specifications described herein at any time, without notice, at IDT's sole discretion. Performance specifications and operating parameters of the described products are determined in an independent state and are not guaranteed to perform the same way when installed in customer products. The information contained herein is provided without representation or warranty of any kind, whether express or implied, including, but not limited to, the suitability of IDT's products for any particular purpose, an implied warranty of merchantability, or non-infringement of the intellectual property rights of others. This document is presented only as a guide and does not convey any license under intellectual property rights of IDT or any third parties.

IDT's products are not intended for use in applications involving extreme environmental conditions or in life support systems or similar devices where the failure or malfunction of an IDT product can be reasonably expected to significantly affect the health or safety of users. Anyone using an IDT product in such a manner does so at their own risk, absent an express, written agreement by IDT.

Integrated Device Technology, IDT and the IDT logo are trademarks or registered trademarks of IDT and its subsidiaries in the United States and other countries. Other trademarks used herein are the property of IDT or their respective third party owners. For datasheet type definitions and a glossary of common terms, visit www.idt.com/go/glossary. Integrated Device Technology, Inc.. All rights reserved.