

Model No.: XT25SC40-04  
 Product Line: Tymphany

Rev: 1  
 Last Update: 2017-03-03 02:00:02

## Product Description

This member of the XT tweeter family utilizes two Tymphany technologies to deliver exceptional sound quality: the ring radiator patent, and the central waveguide patent. This model features a 4 ohm 25 mm voice coil, mounted in a neodymium magnet motor. The tweeter also features a rear chamber to create extended low frequency response. This tweeter is ready-made to be adapted to any compact faceplate.



## Mechanical Drawing

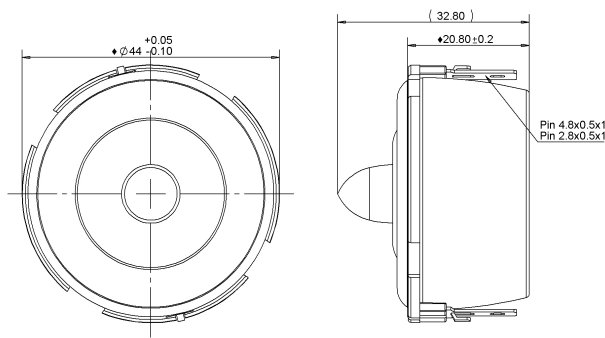

## Specifications

DC Resistance	Revc	Ohms	3.22	5.0%	Energy Bandwidth Product	EBP	(1/Qes)*fs	
Minimum Impedance	Zmin	Ohms	3.79	7.5%	Moving Mass	Mms	g	0.3
Voice Coil Inductance	Le	mH	0.01		Suspension Compliance	Cms	um/N	78
Resonant Frequency	Fs	Hz	1018.45	15%	Effective Cone diameter	D	cm	3.2
Mechanical Q Factor	Qms		2.53		Effective Piston Area	Sd	cm <sup>2</sup>	8
Electrical Q Factor	Qes		0.83		Effective Volume	Vas	L	0.01
Total Q Factor	Qts		0.63		Motor Force Factor	BL	Tm	2.58
Ratio Fs/Qts	F	Fs/Qts	1629.51		Motor Efficiency Factor	β	(T*M <sup>2</sup> )/Ohms	2.1
Half Space Sensitivity @2.83V	db@2.83V/1M	dB	91.11	+/- 1.0db	Voice coil former Material	VCfm		ASV
Half Space Sensitivity @1W/1M	db@1W/1M	dB	87.9	+/- 1.0db	Voice coil inner diameter	VCd	mm	25.76
Gap Height	Gh	mm	2		Rated Noise Power	P	W	100
Maximum Linear Excursion	Xmax	mm	0.1		Test Spectrum Bandwidth			2.5kHz - 20kHz
Ferrofluid Type	FF				Driver Size	Inch		25 mm
Driver Mass	Kg		0.08					

## Frequency and Impedance Response

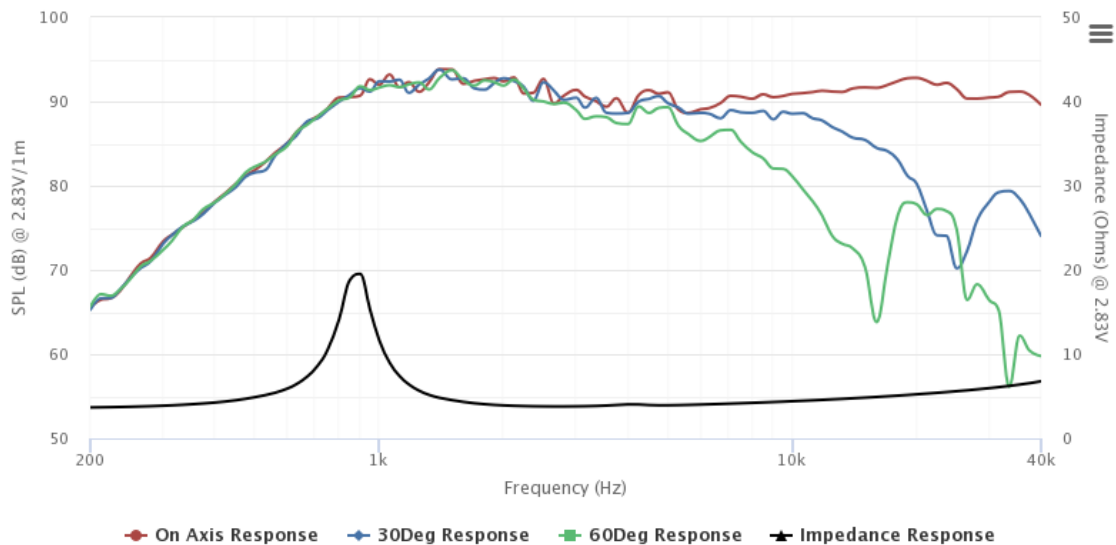

Highcharts.com