

# FS5700 SERIES PUSHBUTTON SWITCH

ANTI-VANDAL SWITCHES  
DETECTOR SWITCHES  
DIP SWITCHES  
KEYLOCK SWITCHES  
NAVIGATION SWITCHES  
PUSHBUTTON SWITCHES  
ROCKER SWITCHES  
ROTARY SWITCHES  
SLIDE SWITCHES  
SNAP ACTION SWITCHES  
TACTILE SWITCHES  
TOGGLE SWITCHES  
CAP OPTIONS

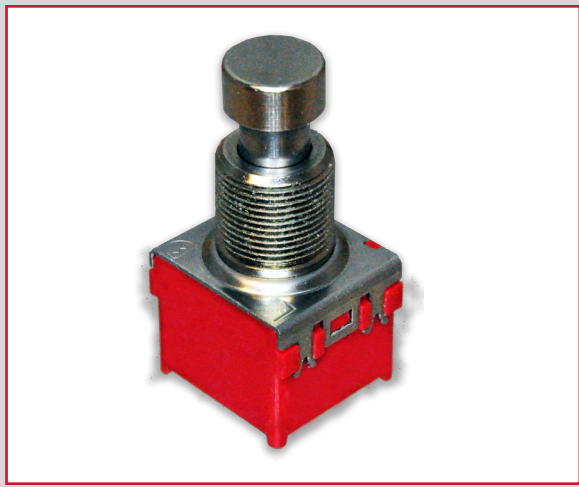

## APPLICATIONS / MARKETS



Gaming: Flight Simulation



Home Appliances



Floor Care Appliances



Industrial Controls



Medical / Dental



Foot Switch

# RoHS

## SPECIFICATIONS

**Contact Rating:** 1A @ 9VDC  
**Electrical Life:** 30,000 Cycles  
**Contact Resistance:** 50mΩ Initial  
**Insulation Resistance:** 100MΩ @ 500VDC  
**Dielectric Strength:** 1000V RMS  
**Operating Temperature:** -10°C to 70°C  
**Storage Temperature:** -10°C to 70°C  
**Full Travel:** SP & DP: 2.7mm; 3P: 5.0mm  
**Contact Arrangement:** SPDT, DPDT or 3PDT  
**Actuation Force:** Single pole momentary: 1700gf  
 Single pole alternate action: 1000gf  
 Double pole momentary: 2500gf  
 Double pole alternate action: 1600gf  
 3 pole alternate action: 3000gf  
**Panel Thickness:** 8mm Max.

## FEATURES & BENEFITS

- SPDT, DPDT or 3PDT
- Momentary or alternate action functions
- High actuation force
- PCB mount or panel mount option

## PART NUMBER CONFIGURATOR

Series	Circuit	Function	Actuator	Bushing	Terminal	Contact Material	Sealing	Hardware
FS5700	SP - Single Pole DP - Double Pole 3P* - 3 Pole	L - Alternate Action M - Momentary	T2 - 10mm dia.	B2 - 11.5 high	M1 - Solder Lug M2 - PCB Pins	Q - Silver	E - Epoxy	H** - Hardware

\*3P only available in "L" function  
 \*\*Hardware only provided with "M1" termination

*Specifications subject to change without notice*



**E-SWITCH®**

www.e-switch.com

800.867.2717

1

# FS5700 SERIES PUSHBUTTON SWITCH

## SINGLE POLE

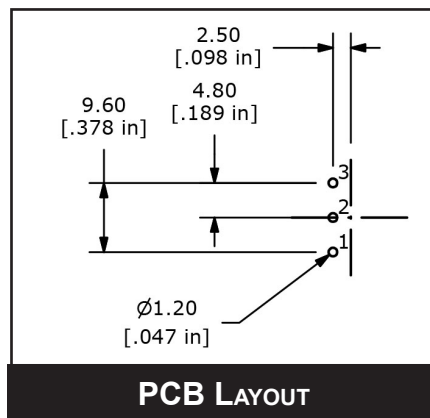
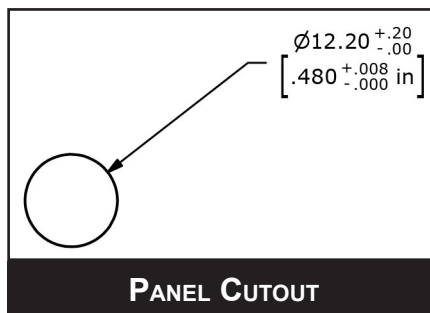
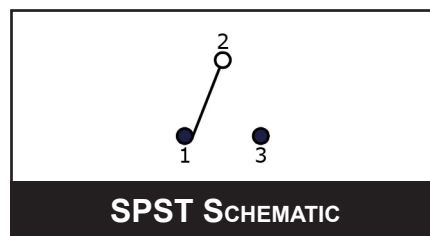
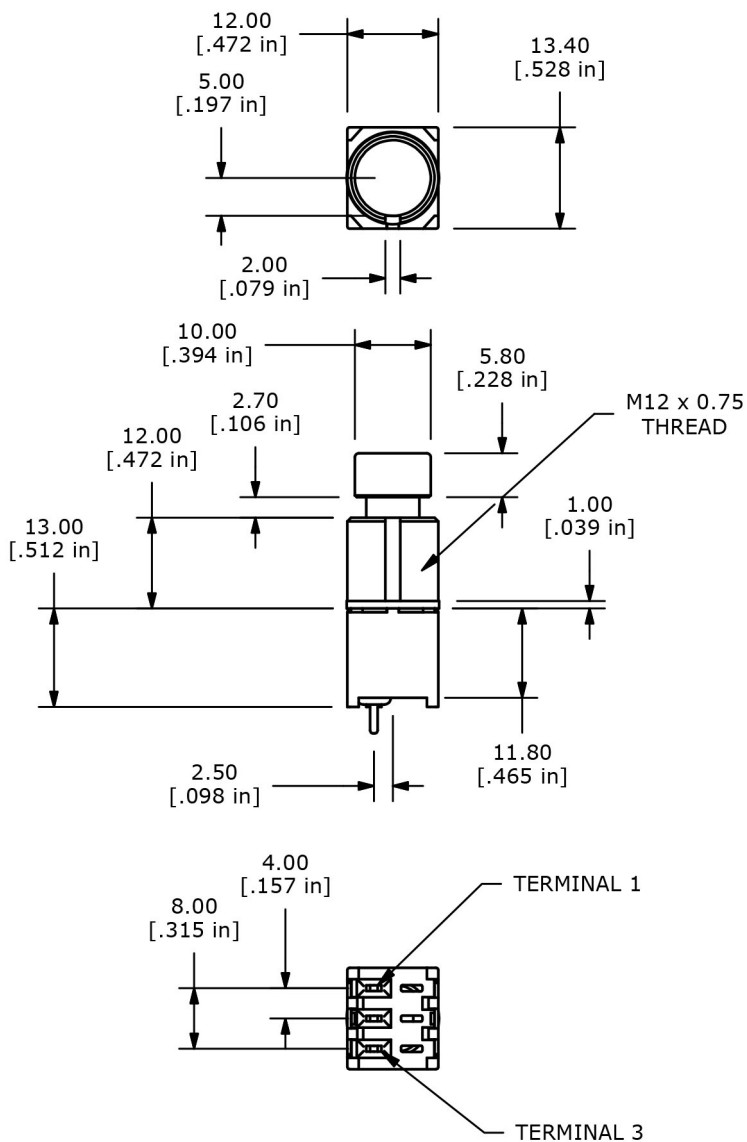

# FS5700 SERIES PUSHBUTTON SWITCH

## DOUBLE POLE

- ANTI-VANDAL SWITCHES
- DETECTOR SWITCHES
- DIP SWITCHES
- KEYLOCK SWITCHES
- NAVIGATION SWITCHES
- PUSHBUTTON SWITCHES**
- ROCKER SWITCHES
- ROTARY SWITCHES
- SLIDE SWITCHES
- SNAP ACTION SWITCHES
- TACTILE SWITCHES
- TOGGLE SWITCHES
- CAP OPTIONS

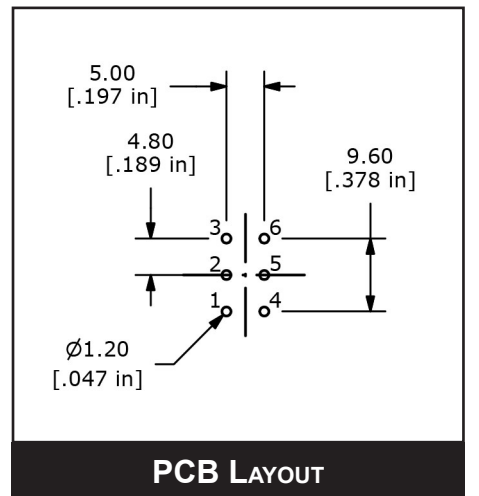
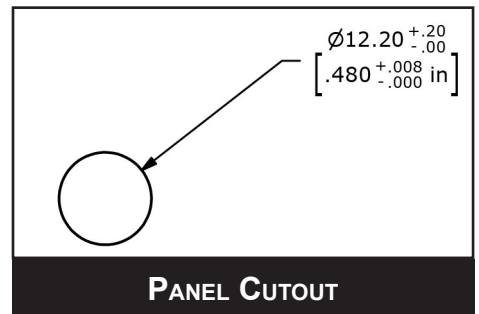
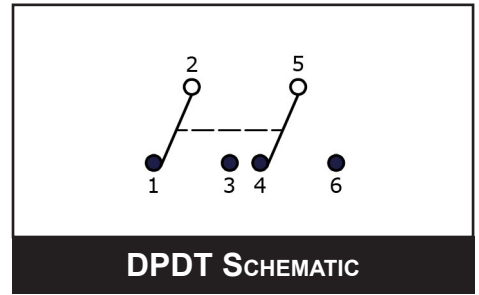
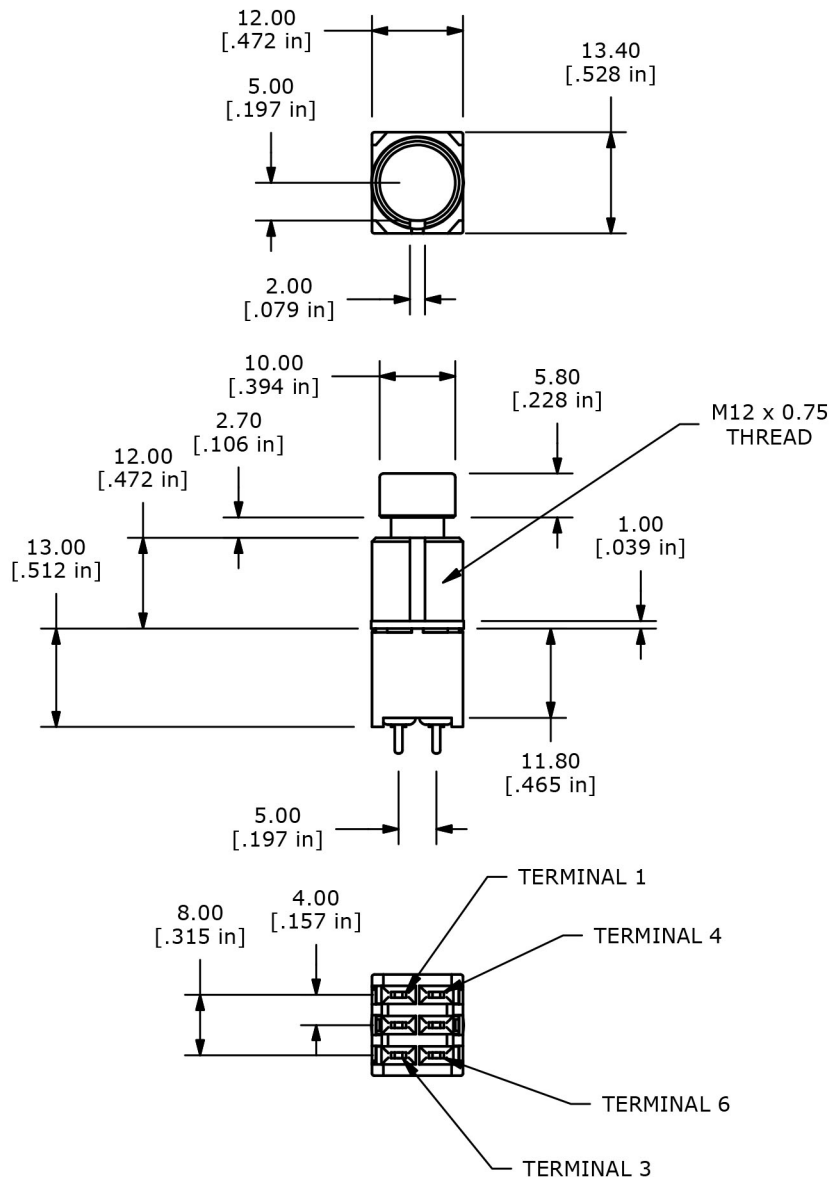

# FS5700 SERIES PUSHBUTTON SWITCH

TRIPLE POLE

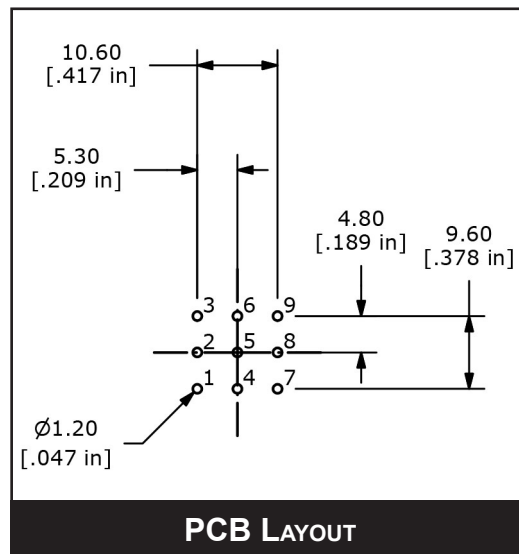
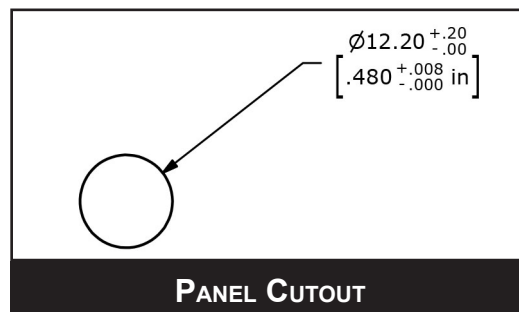
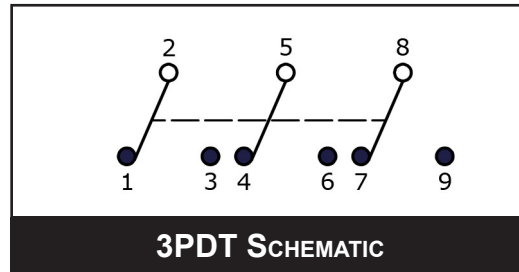
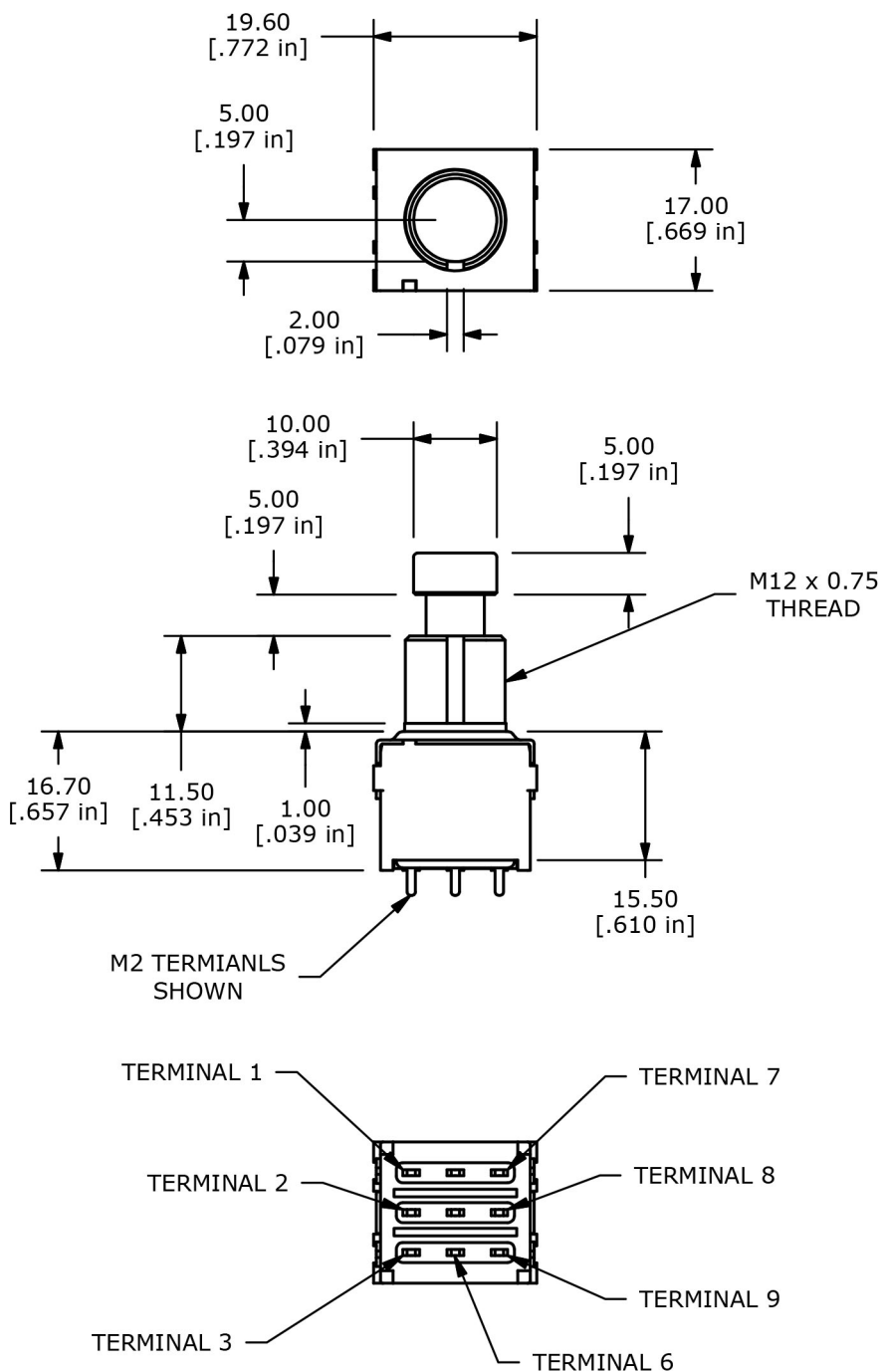

ANTI-VANDAL SWITCHES  
 DETECTOR SWITCHES  
 DIP SWITCHES  
 KEYLOCK SWITCHES  
 NAVIGATION SWITCHES  
 PUSHBUTTON SWITCHES  
 ROTARY SWITCHES  
 ROTARY SWITCHES  
 SLIDE SWITCHES  
 SNAP ACTION SWITCHES  
 TACTILE SWITCHES  
 TOGGLE SWITCHES  
 CAP OPTIONS

## TERMINATION

### M1 TERMINATION

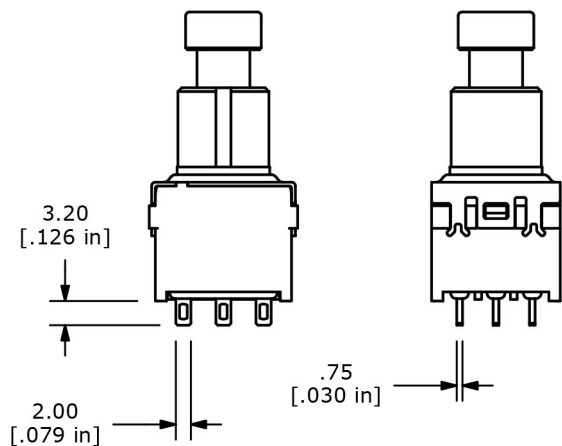

### M2 TERMINATION

