

产品说明 Product Description

- ◆ Surface Material: ABS resin (flame retardant, ultraviolet radiation resistant properties).
表面材质：ABS树脂（难燃，耐紫外线特性）。
- ◆ Mesh material: Nylon fibers synthetic resin.
滤网材质：尼龙纤维合成树脂。
- ◆ Filter need regular cleaning, in order to maintain ventilation filtering effect.
过滤网需定期清洁，以维持通过滤网的效果。
- ◆ Protection class: IP44.
防护等级：IP44
- ◆ Suitable for supporting the use 172×150 mm series fan.
适用于172×150 mm系列风扇配套使用。

Ventilation filtering window group 通风过滤窗组
GLC-804 172 × 150mm

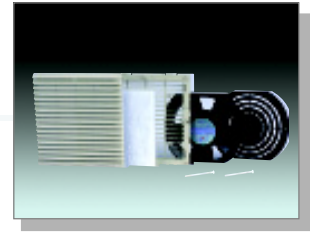
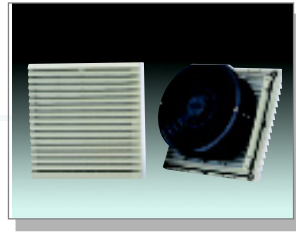
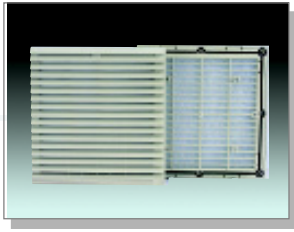
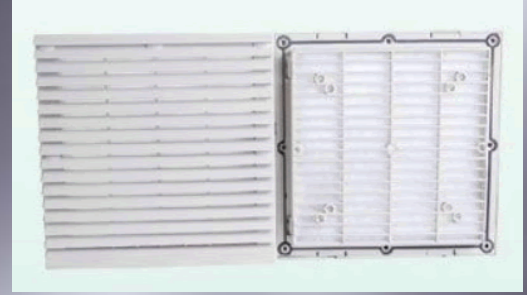

外形图 Dimensions(Unit:mm)

[按 装 方 法]
[INSTALLATION MENTHOD]

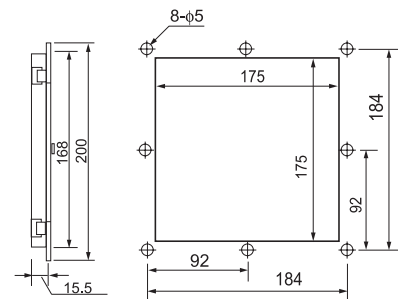
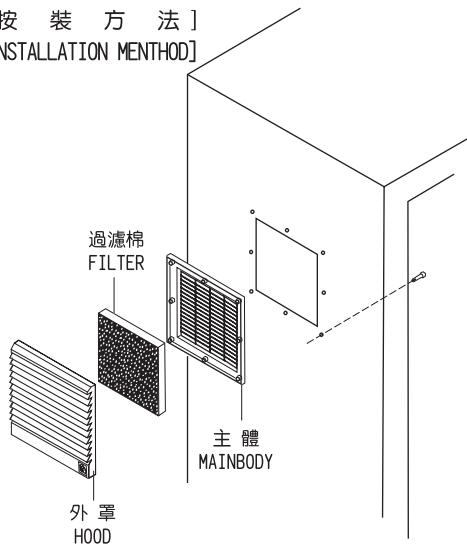

開孔尺寸
PANEL OPENING
SIZE

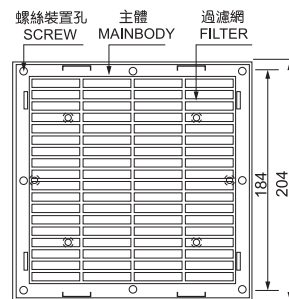
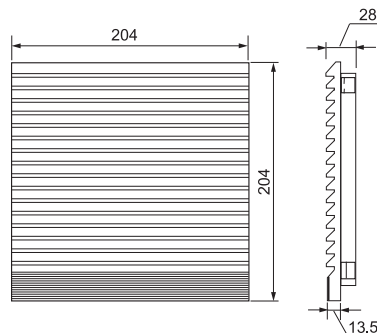

Thank you for evaluating Wondershare PDF Password Remover.

With the trial version, only the first 5 pages of each file can be exported.

To get all the pages exported, you need to purchase the software from

<http://www.anypdftools.com/buy/buy-pdf-password-remover.html>